



www.sportsfield.com | 888-975-3343

*Excellence from
Design to Installation*



Seasonal & Semi-Permanent Fencing

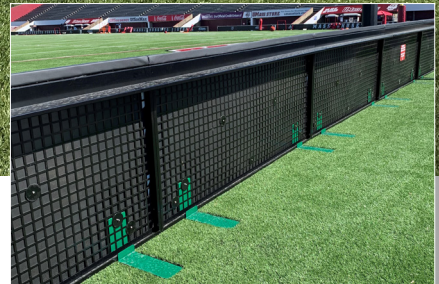

Sportsfield Specialties, Inc. 41155 State Hwy 10. Delhi, NY 13753

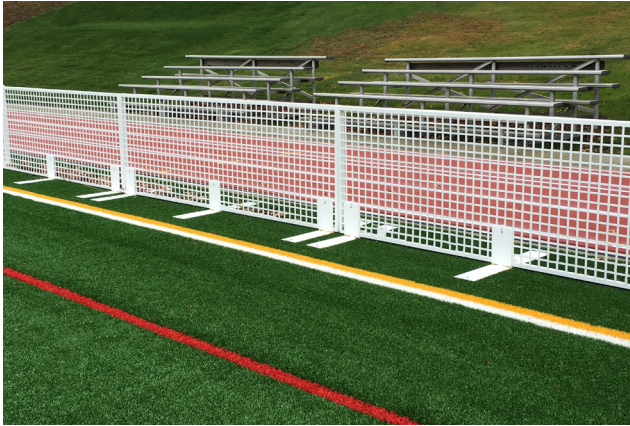

Seasonal & Semi-Permanent Fencing

Product Overview

- Seasonal and semi-permanent multi-use fencing solutions
- Ideal for outfield fencing and spectator/crowd control barriers
- Free-standing base or semi-permanent ground sleeve designs
- NEW semi-permanent structural fencing system with integral wall pads
- Durable powder coated finish available in a variety of standard colors
- Optional high resolution digital graphics and lettering

Item Number	Product Description
SF4PT	4'H seasonal fencing system, free-standing base
SF4PTP	Optional wall pads for 4'H seasonal fencing system
SF4	4'H semi-permanent fencing system, ground sleeve inserted
SF4P	Optional wall pads for 4'H semi-permanent fencing system
SF4S	4'H semi-permanent structural fencing system with integral wall pads, ground sleeve inserted
SF6	6'H semi-permanent fencing system, ground sleeve inserted
SF6P	Optional wall pads for 6'H semi-permanent fencing system
SF6S	6'H semi-permanent structural fencing system with integral wall pads, ground sleeve inserted
SF8S	8'H semi-permanent structural fencing system with integral wall pads, ground sleeve inserted

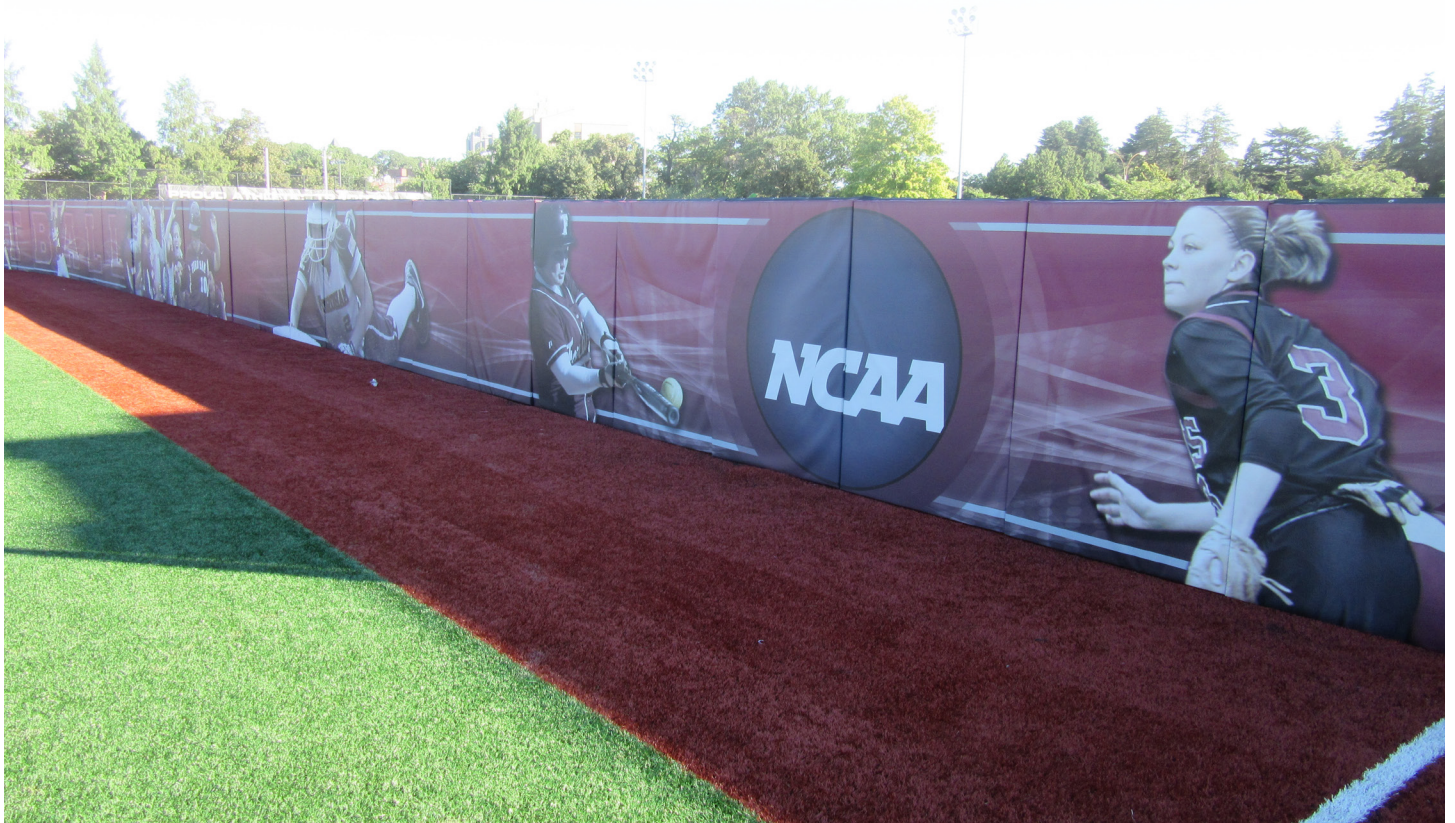

Optional Padding SFPT4P Available

Standard Powder Coat Finish,
Various Colors Available

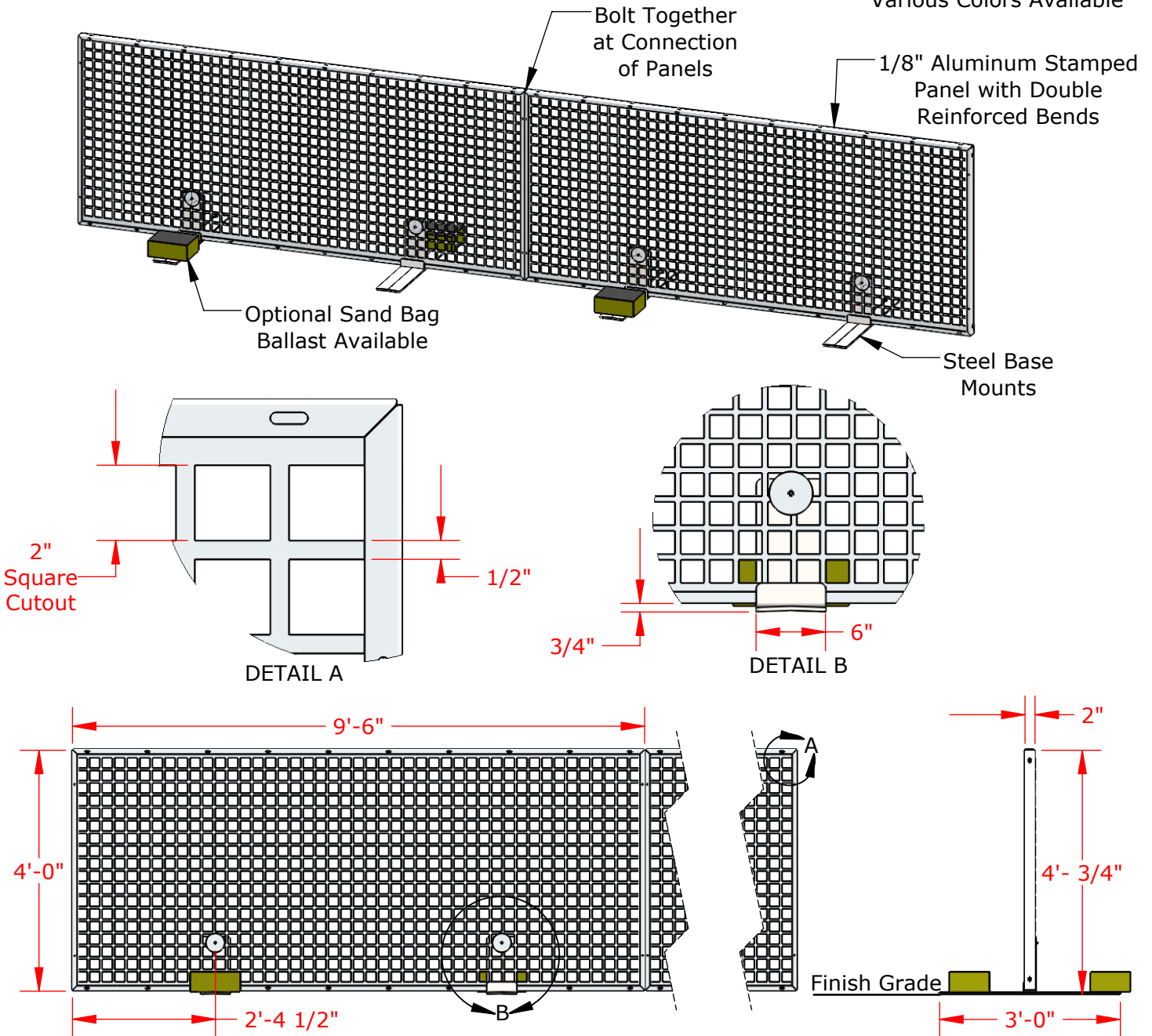

Wind speeds noted below indicate anticipated overturning, place corresponding ballast on alternating sides of each base mount as required

No Sand Bag	50 LB. Sand Bag	75 LB. Sand Bag	100 LB. Sand Bag
30 MPH	45 MPH	50 MPH	55 MPH

PROPRIETARY AND CONFIDENTIAL

THE INFORMATION CONTAINED IN THIS DRAWING IS THE SOLE PROPERTY OF SPORTSFIELD SPECIALTIES INC. ANY REPRODUCTION IN PART OR AS A WHOLE WITHOUT THE WRITTEN PERMISSION OF SPORTSFIELD SPECIALTIES INC. IS PROHIBITED.

SFPT4 4'H Seasonal Fence System

Not To Scale

Sportsfield Specialties Inc 02182020

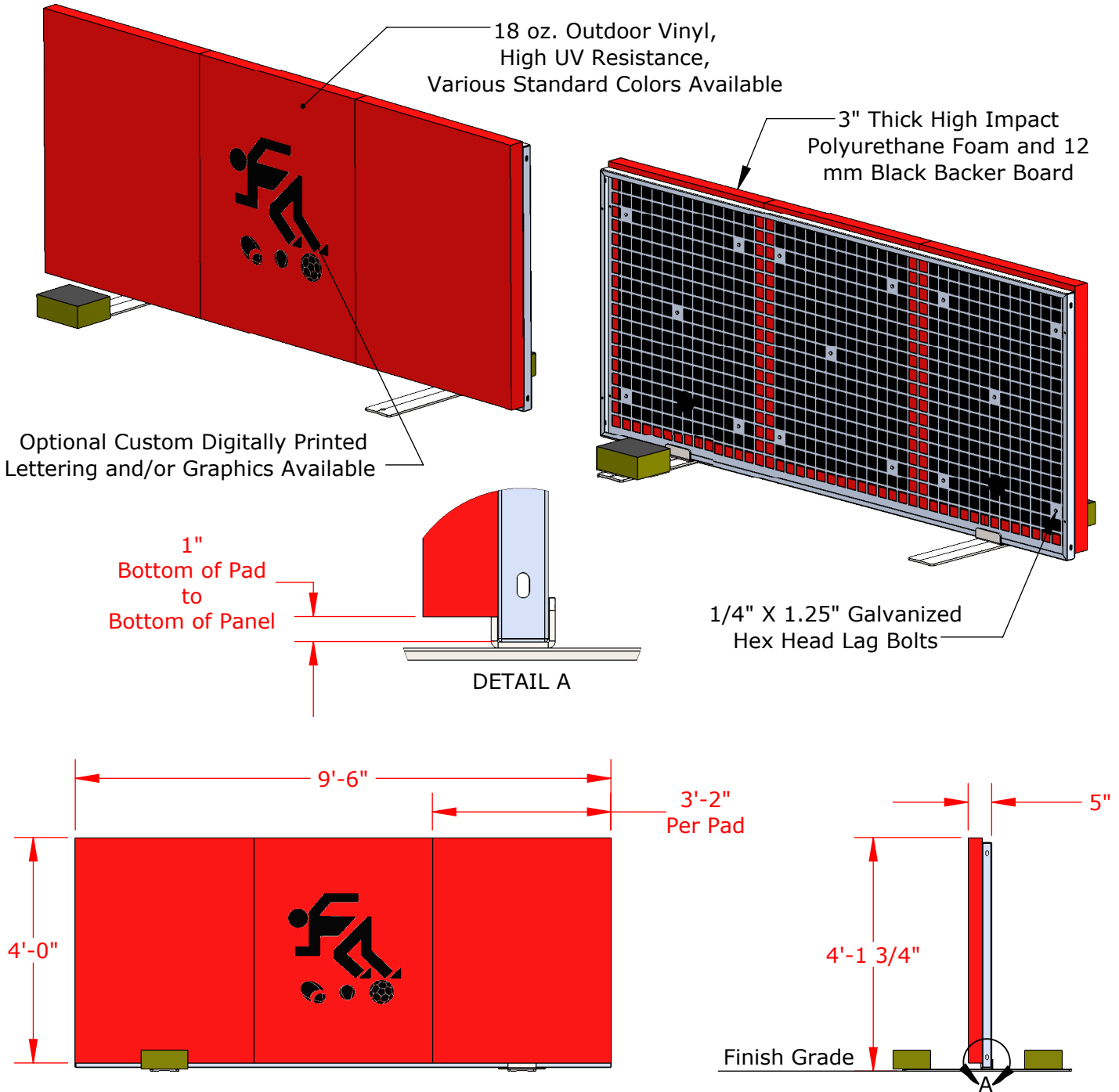

Wind speeds noted below indicate anticipated overturning, place corresponding ballast on alternating sides of each base mount as required

No Sand Bag	50 LB. Sand Bag	75 LB. Sand Bag	100 LB. Sand Bag
30 MPH	45 MPH	50 MPH	55 MPH

PROPRIETARY AND CONFIDENTIAL

THE INFORMATION CONTAINED IN THIS DRAWING IS THE SOLE PROPERTY OF SPORTSFIELD SPECIALTIES INC. ANY REPRODUCTION IN PART OR AS A WHOLE WITHOUT THE WRITTEN PERMISSION OF SPORTSFIELD SPECIALTIES INC. IS PROHIBITED.

SFPT4P

4'H Seasonal Fence System Padding

Not To Scale

Sportsfield Specialties Inc 08262020

2" WEB NYLON HANDLES FOR TRANSPORT PURPOSES (BOTH ENDS)



YELLOW VINYL SAND BAG WITH SSI DIGITALLY PRINTED LOGO, ZIPPER/VELCRO FLAP CLOSURE, HOLDS APPROXIMATELY 50 LBS. OF SAND (SAND NOT INCLUDED)



PROPRIETARY AND CONFIDENTIAL

THE INFORMATION CONTAINED IN THIS DRAWING IS THE SOLE PROPERTY OF SPORTSFIELD SPECIALTIES INC. ANY REPRODUCTION IN PART OR AS A WHOLE WITHOUT THE WRITTEN PERMISSION OF SPORTSFIELD SPECIALTIES INC. IS PROHIBITED.

SB50 - 50 LB. SAND BAG

NOT TO SCALE

SPORTSFIELD SPECIALTIES INC 05082018

2" WEB NYLON HANDLES FOR TRANSPORT PURPOSES
(BOTH ENDS)

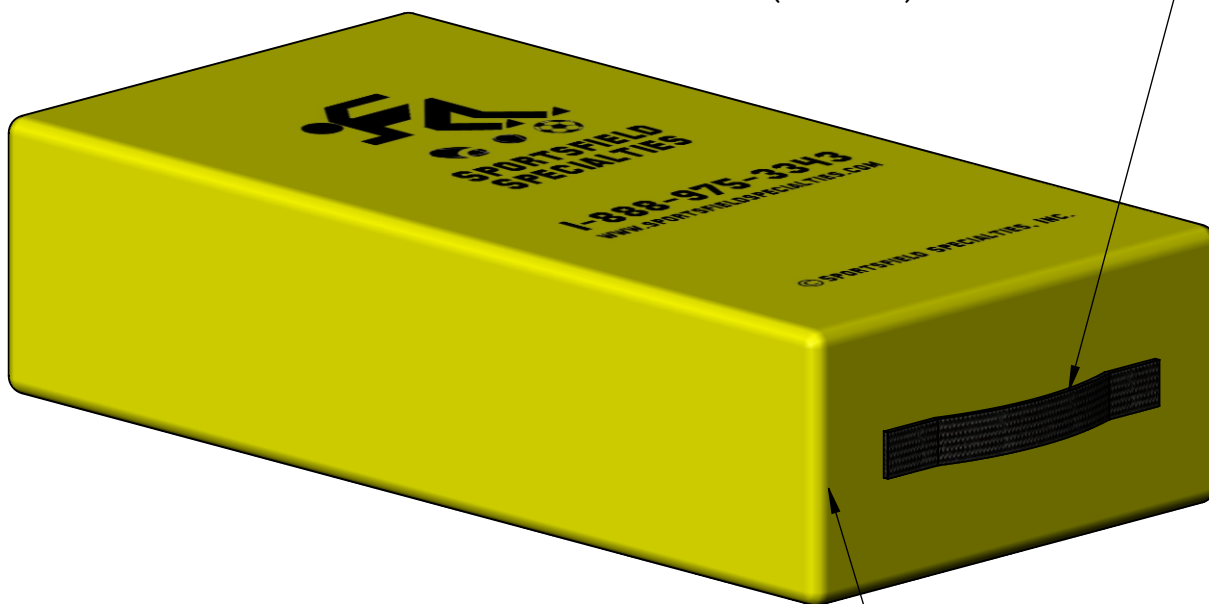

YELLOW VINYL SAND BAG WITH SSI DIGITALLY PRINTED LOGO,
ZIPPER/VELCRO FLAP CLOSURE, HOLDS APPROXIMATELY
75 LBS. OF SAND (SAND NOT INCLUDED)

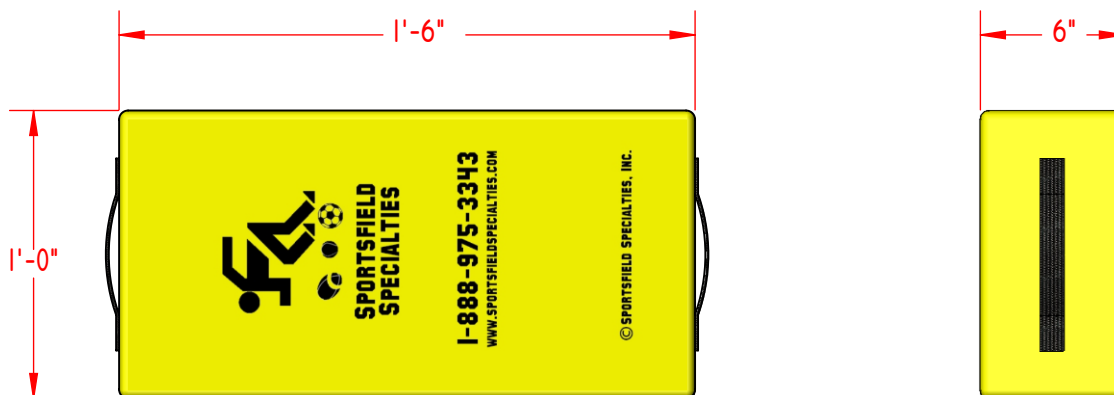

PROPRIETARY AND CONFIDENTIAL

THE INFORMATION CONTAINED IN THIS DRAWING IS THE SOLE PROPERTY OF SPORTSFIELD SPECIALTIES INC. ANY REPRODUCTION IN PART OR AS A WHOLE WITHOUT THE WRITTEN PERMISSION OF SPORTSFIELD SPECIALTIES INC. IS PROHIBITED.

SB75 - 75 LB. SAND BAG

NOT TO SCALE

SPORTSFIELD SPECIALTIES INC 05052018

2" WEB NYLON HANDLES FOR TRANSPORT PURPOSES
(BOTH ENDS)

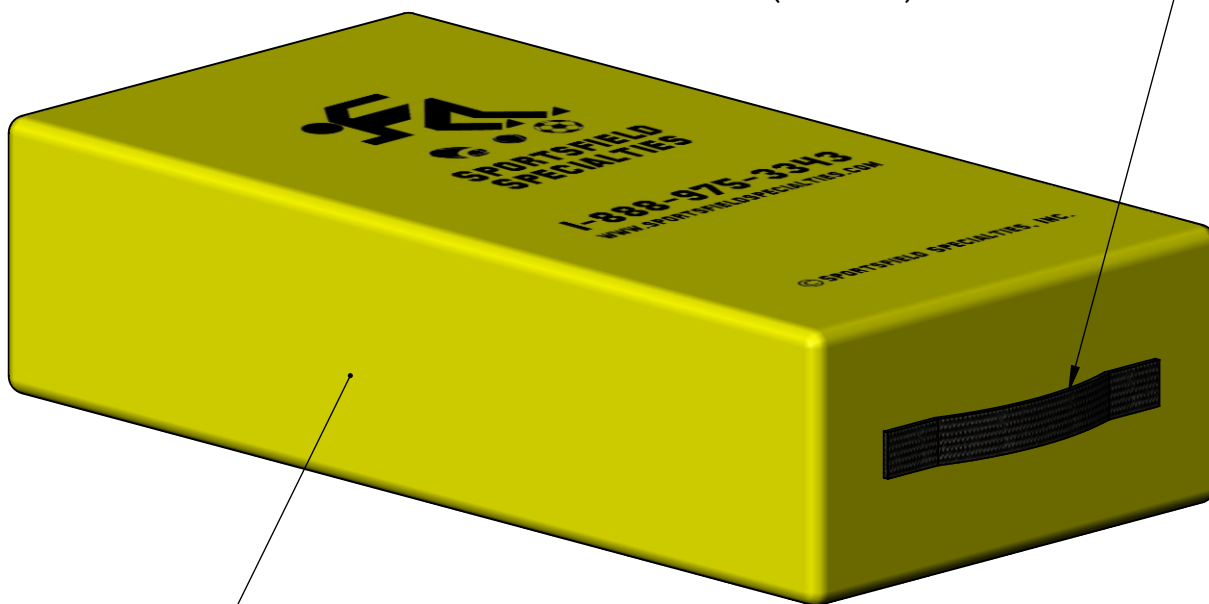

YELLOW VINYL SAND BAG WITH SSI DIGITALLY PRINTED LOGO,
ZIPPER/VELCRO FLAP CLOSURE, HOLDS APPROXIMATELY
100 LBS. OF SAND (SAND NOT INCLUDED)

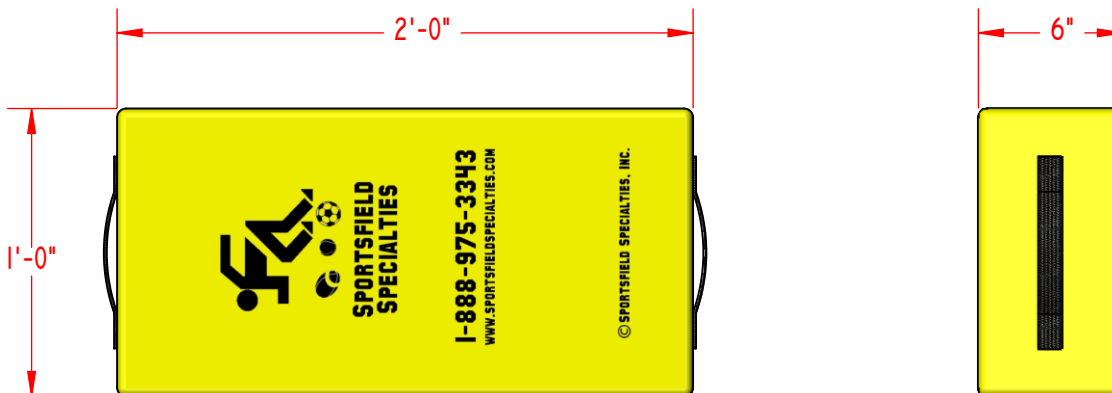

PROPRIETARY AND CONFIDENTIAL

THE INFORMATION CONTAINED IN THIS DRAWING IS THE SOLE PROPERTY OF SPORTSFIELD SPECIALTIES INC. ANY REPRODUCTION IN PART OR AS A WHOLE WITHOUT THE WRITTEN PERMISSION OF SPORTSFIELD SPECIALTIES INC. IS PROHIBITED.

SBI00 - 100 LB. SAND BAG

NOT TO SCALE

SPORTSFIELD SPECIALTIES INC 05082018

Optional Padding SF4P Available

Standard Powder Coated Finish, Various Colors Available

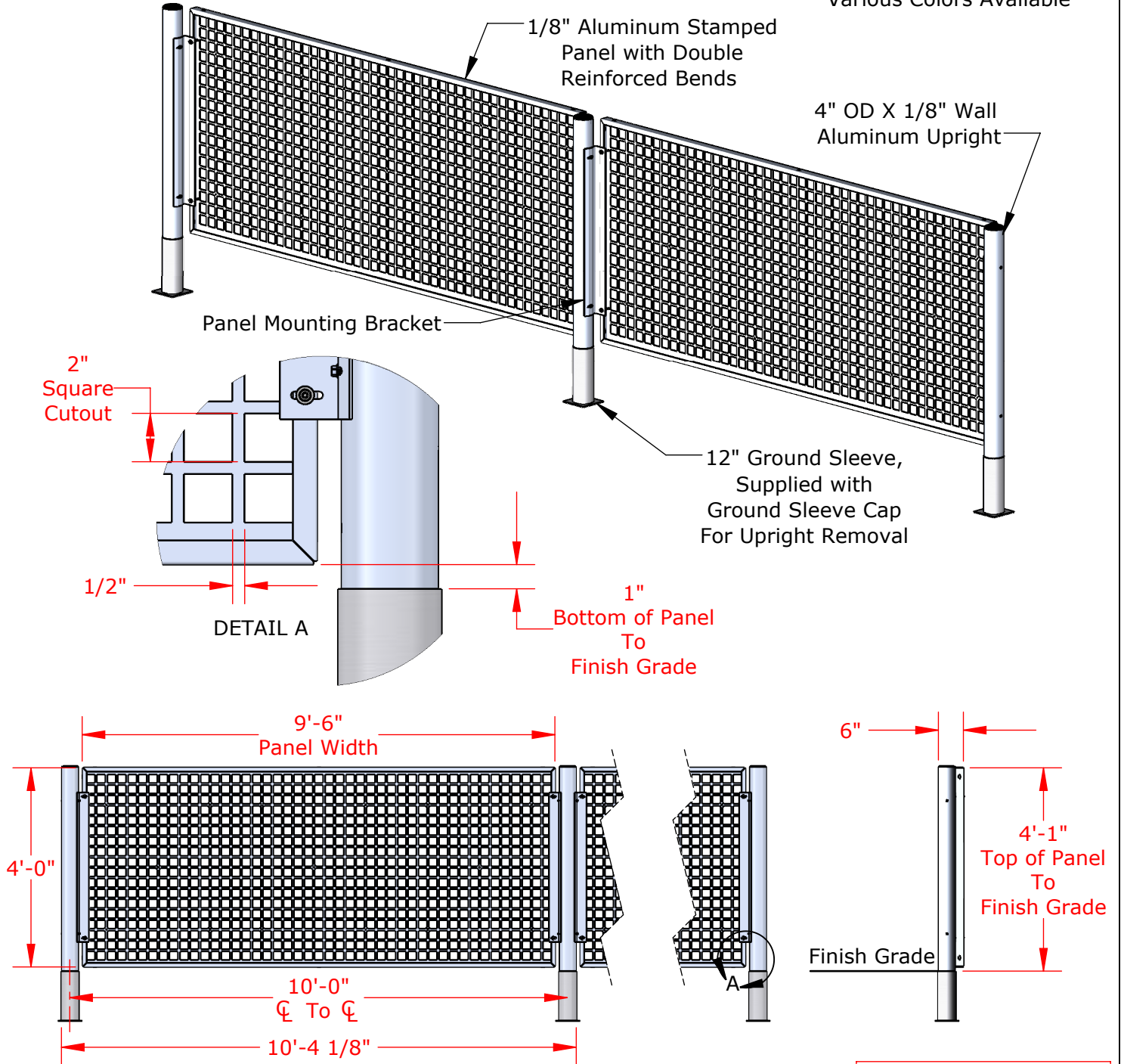

Foundation requirements based on local codes and soil conditions

PROPRIETARY AND CONFIDENTIAL

THE INFORMATION CONTAINED IN THIS DRAWING IS THE SOLE PROPERTY OF SPORTSFIELD SPECIALTIES INC. ANY REPRODUCTION IN PART OR AS A WHOLE WITHOUT THE WRITTEN PERMISSION OF SPORTSFIELD SPECIALTIES INC. IS PROHIBITED.

Not To Scale

SF4 4'H Semi-Permanent Fence System

Sportsfield Specialties Inc 03252021

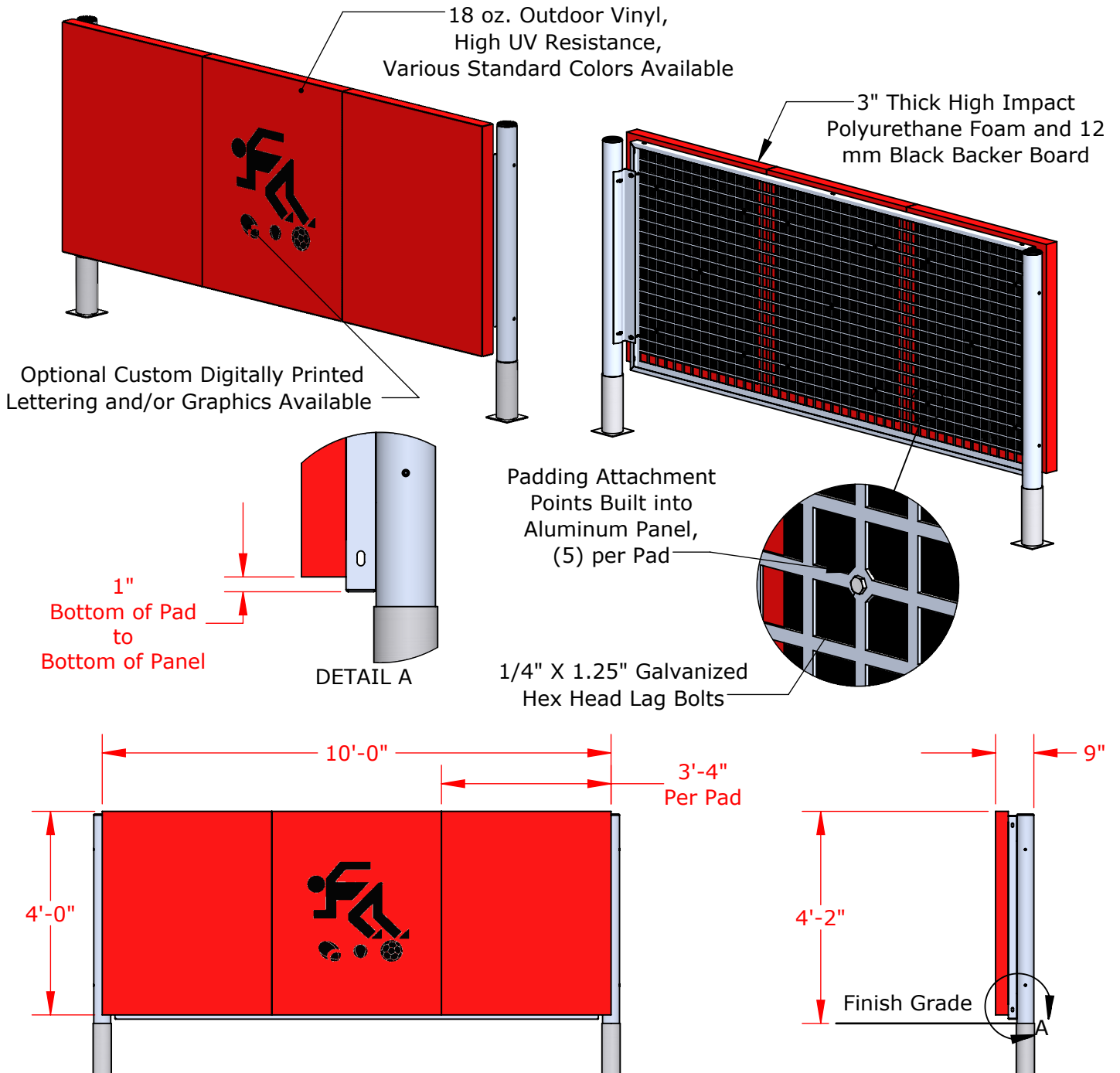

Part No.	Description
SF4P	4' High Semi-Permanent Fence System Padding
SF4PDG	4' High Semi-Permanent Fence System Padding, Digital Graphics

PROPRIETARY AND CONFIDENTIAL

THE INFORMATION CONTAINED IN THIS DRAWING IS THE SOLE PROPERTY OF SPORTSFIELD SPECIALTIES INC. ANY REPRODUCTION IN PART OR AS A WHOLE WITHOUT THE WRITTEN PERMISSION OF SPORTSFIELD SPECIALTIES INC. IS PROHIBITED.

SF4P
4'H Semi-Permanent Fence System Padding

Not To Scale

Sportsfield Specialties Inc 03252021

Optional Padding SF6P Available

1/8" Aluminum Stamped Panel with Double Reinforced Bends

Standard Powder Coated Finish, Various Colors Available

4" OD X 1/8" Wall Aluminum Upright

2" Square Cutout

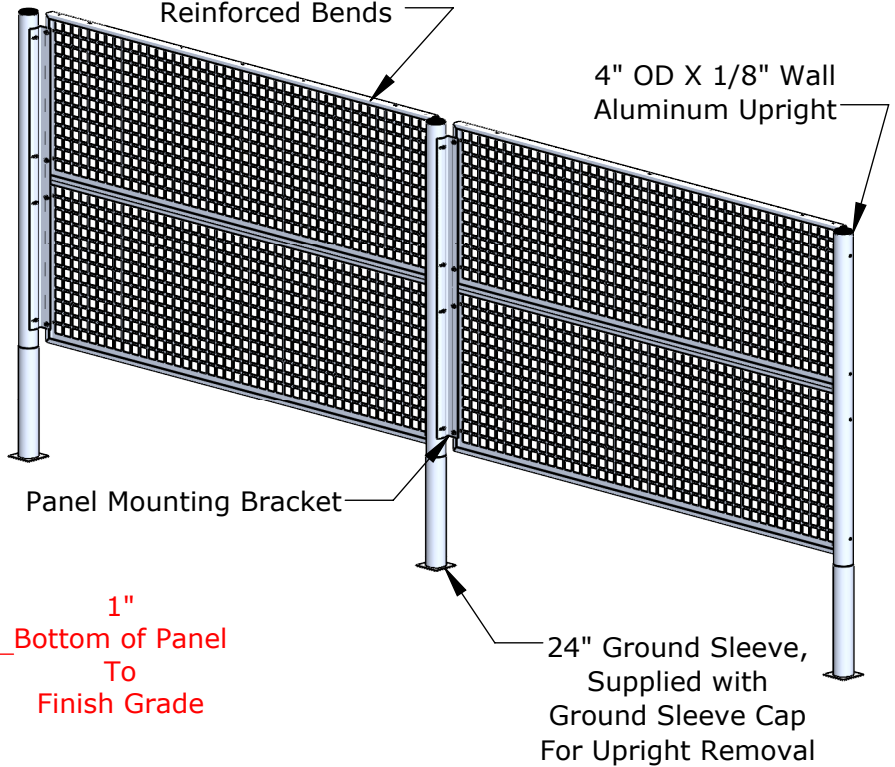

1/2"

1" Bottom of Panel To Finish Grade

DETAIL A

9'-6" Panel Width

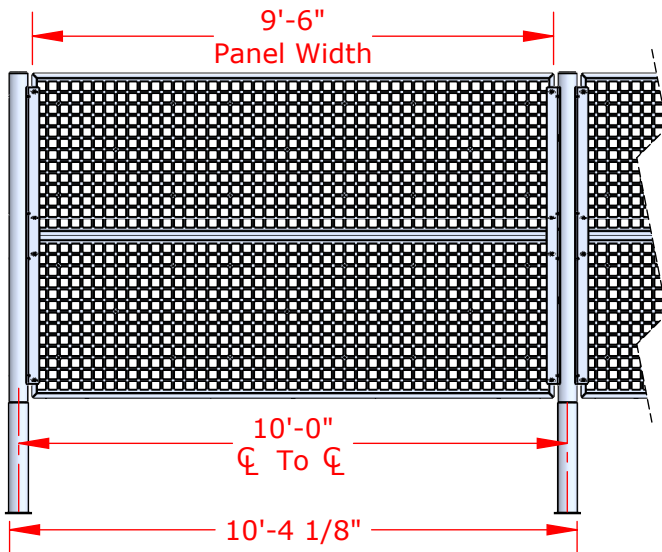

6"

6'-0" Top of Panel To Finish Grade

Finish Grade

Foundation requirements based on local codes and soil conditions

PROPRIETARY AND CONFIDENTIAL

THE INFORMATION CONTAINED IN THIS DRAWING IS THE SOLE PROPERTY OF SPORTSFIELD SPECIALTIES INC. ANY REPRODUCTION IN PART OR AS A WHOLE WITHOUT THE WRITTEN PERMISSION OF SPORTSFIELD SPECIALTIES INC. IS PROHIBITED.

SF6

6'H Semi-Permanent Fence System

Not To Scale

Sportsfield Specialties Inc 03252021

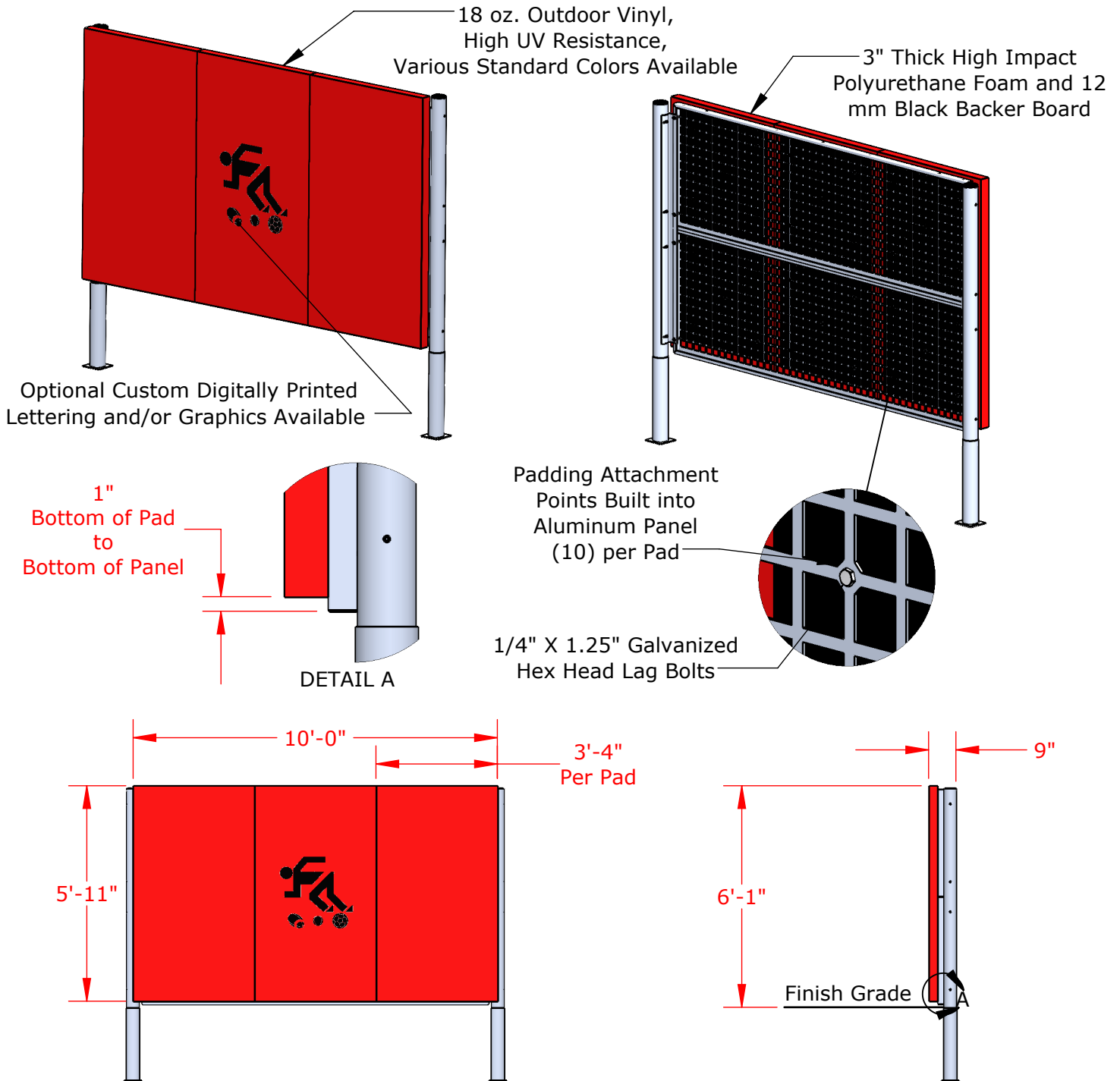

Part No.	Description
SF6P	6' High Semi-Permanent Fence System Padding
SF6PDG	6' High Semi-Permanent Fence System Padding, Digital Graphics

PROPRIETARY AND CONFIDENTIAL

THE INFORMATION CONTAINED IN THIS DRAWING IS THE SOLE PROPERTY OF SPORTSFIELD SPECIALTIES INC. ANY REPRODUCTION IN PART OR AS A WHOLE WITHOUT THE WRITTEN PERMISSION OF SPORTSFIELD SPECIALTIES INC. IS PROHIBITED.

SF6P
6'H Semi-Permanent Fence System Padding

Not To Scale

Sportsfield Specialties Inc 03262021

Customized To Overall Field Dimensions

Foundation Requirements
 Based On Local Codes
 And Soil Conditions

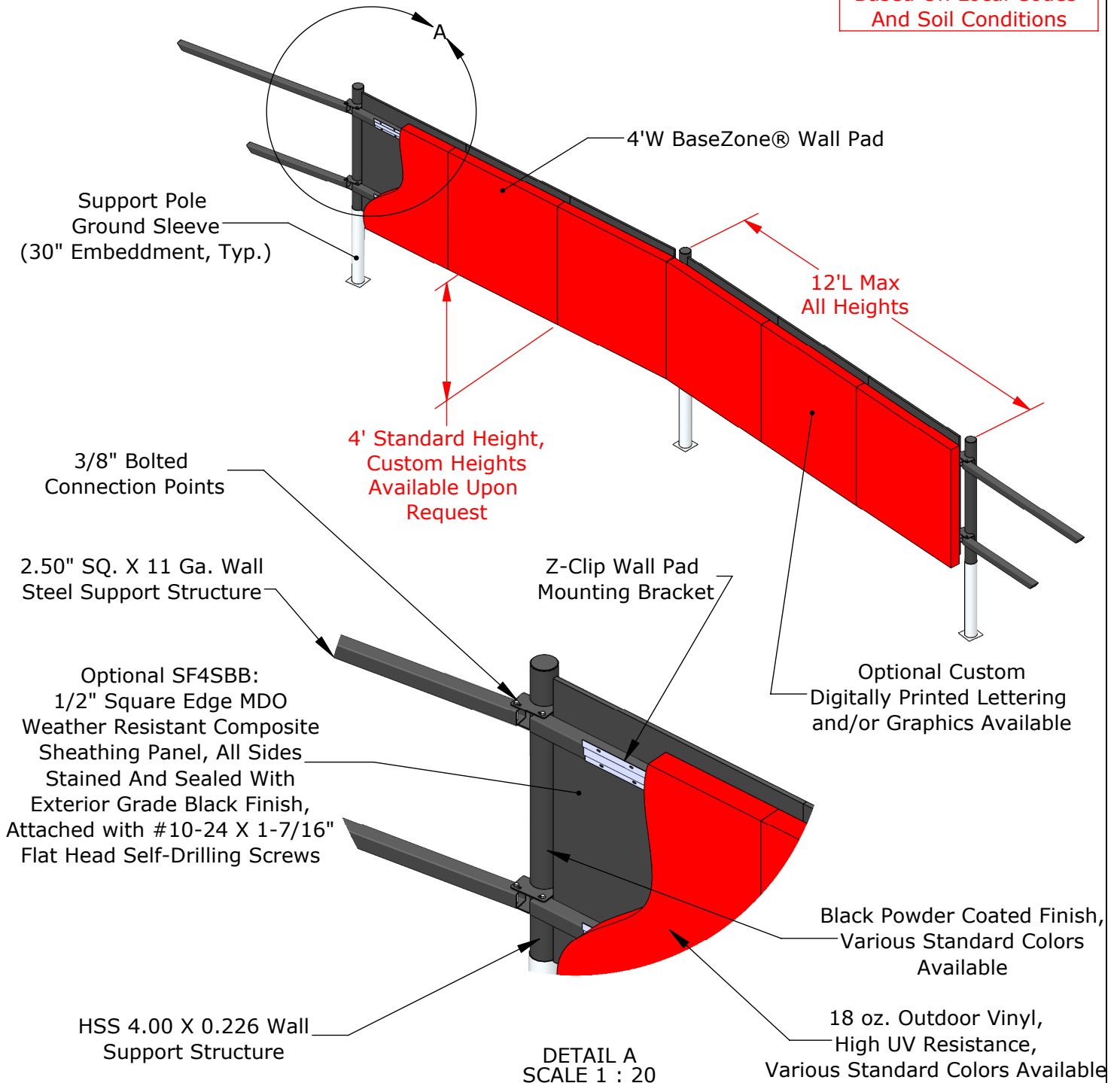

PROPRIETARY AND CONFIDENTIAL

THE INFORMATION CONTAINED IN THIS DRAWING IS THE SOLE PROPERTY OF SPORTSFIELD SPECIALTIES INC. ANY REPRODUCTION IN PART OR AS A WHOLE WITHOUT THE WRITTEN PERMISSION OF SPORTSFIELD SPECIALTIES INC. IS PROHIBITED.

S46S 4'H Semi-Permanent Structural Fence System with Wall Pads

Not To Scale

Sportsfield Specialties Inc 02062024

Customized To Overall Field Dimensions

Foundation Requirements
 Based On Local Codes
 And Soil Conditions

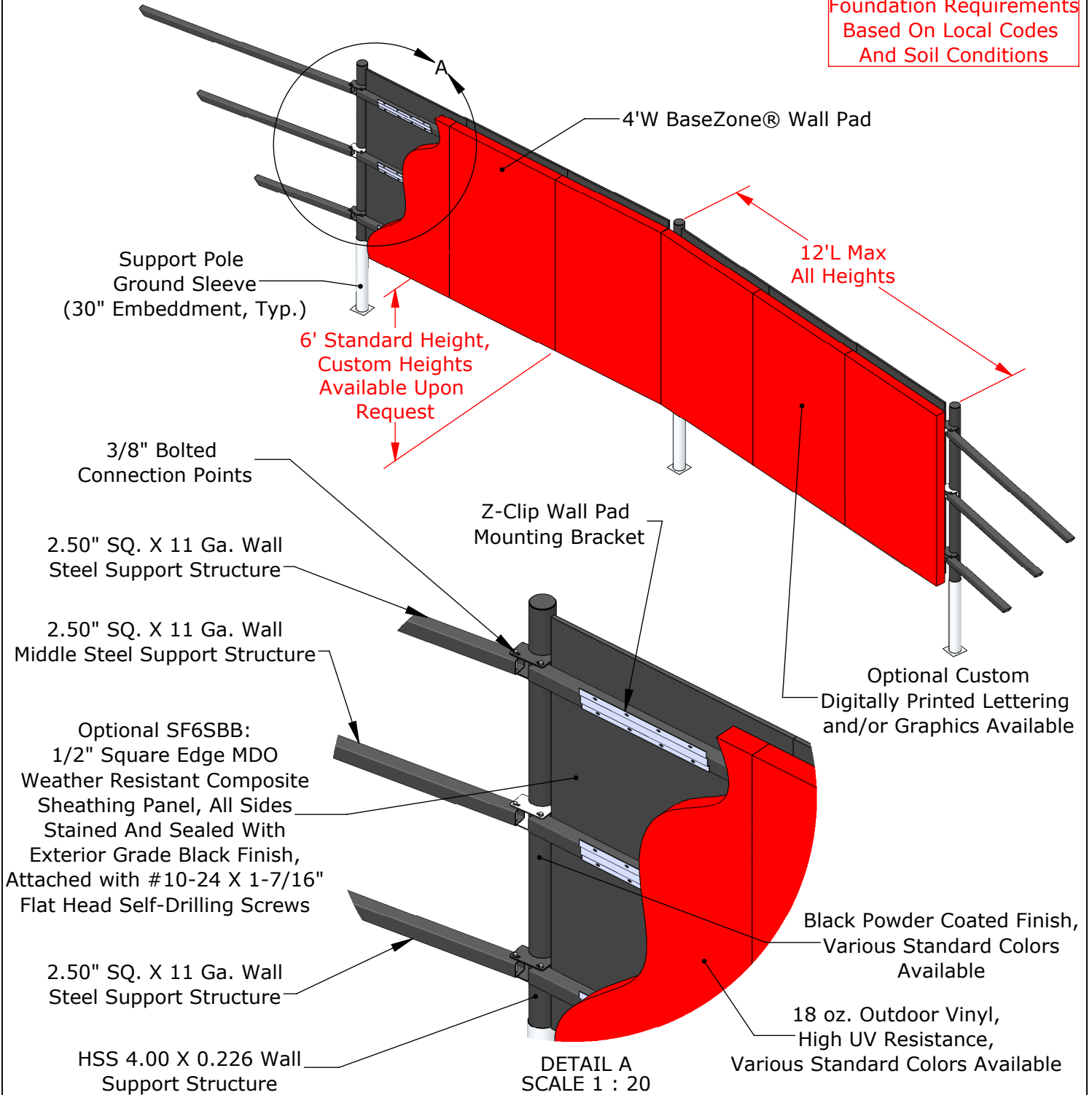

PROPRIETARY AND CONFIDENTIAL

THE INFORMATION CONTAINED IN THIS DRAWING IS THE SOLE PROPERTY OF SPORTSFIELD SPECIALTIES INC. ANY REPRODUCTION IN PART OR AS A WHOLE WITHOUT THE WRITTEN PERMISSION OF SPORTSFIELD SPECIALTIES INC. IS PROHIBITED.

SF6S 6'H Semi-Permanent Structural Fence System with Wall Pads

Not To Scale

Sportsfield Specialties Inc 02052024

Customized To Overall Field Dimensions

Foundation Requirements
 Based On Local Codes
 And Soil Conditions

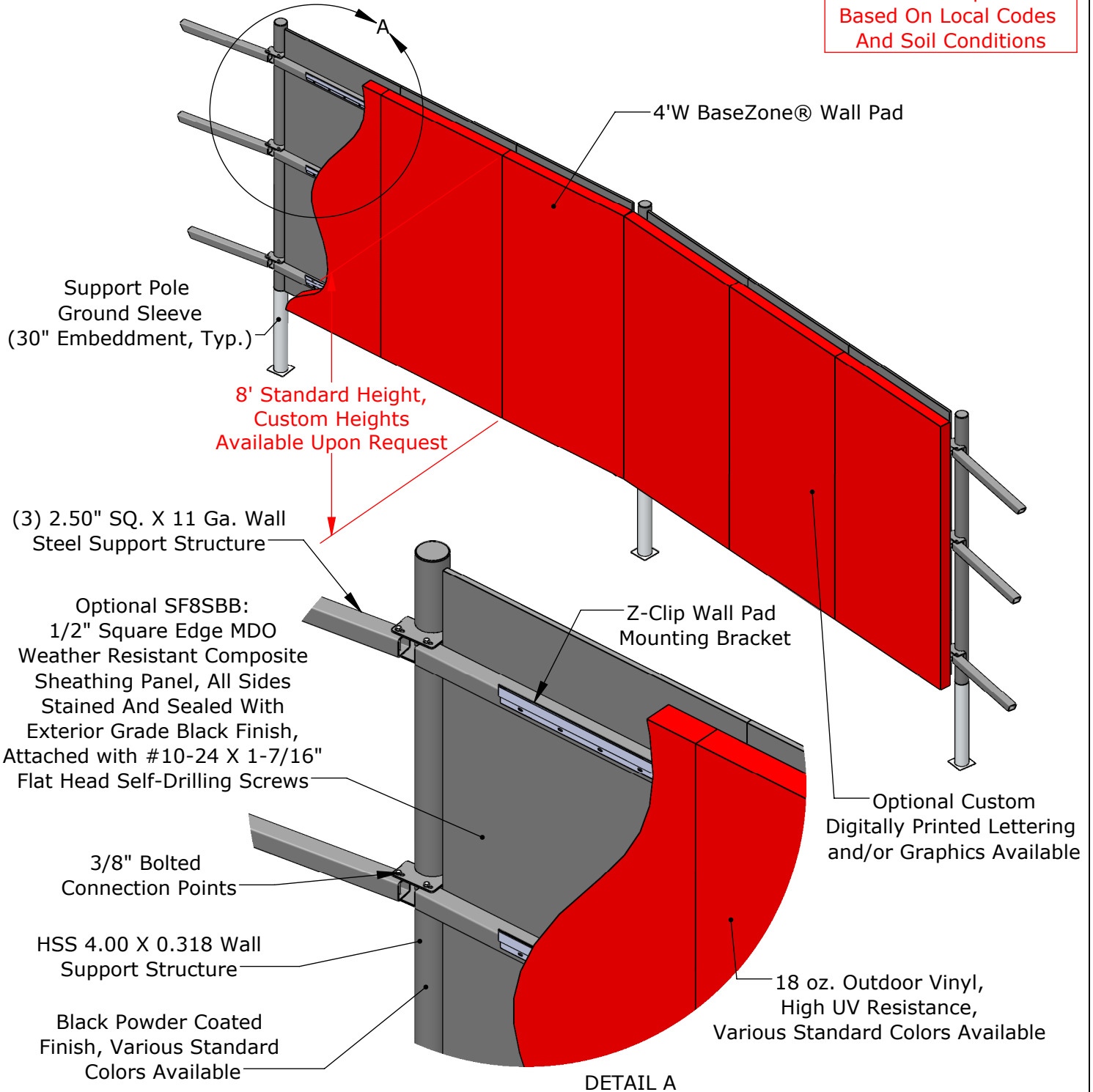

PROPRIETARY AND CONFIDENTIAL

THE INFORMATION CONTAINED IN THIS DRAWING IS THE SOLE PROPERTY OF SPORTSFIELD SPECIALTIES INC. ANY REPRODUCTION IN PART OR AS A WHOLE WITHOUT THE WRITTEN PERMISSION OF SPORTSFIELD SPECIALTIES INC. IS PROHIBITED.

SF8S 8'H Semi-Permanent Structural Fence System With Wall Pads

Not To Scale

Sportsfield Specialties Inc 02062024