

# SPORTSFIELD SPECIALTIES

www.sportsfield.com | 888-975-3343

*Excellence from  
Design to Installation*



**Pitching Mounds & Batter's Boxes**



Sportsfield Specialties, Inc. 41155 State Hwy 10. Delhi, NY 13753

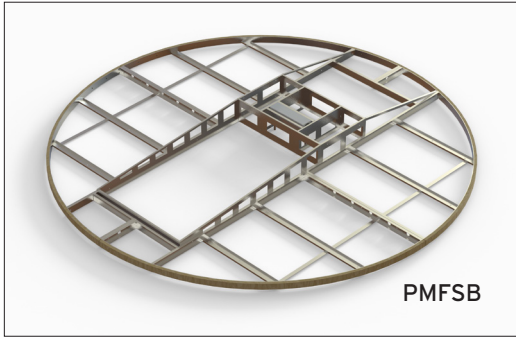

PMFSB

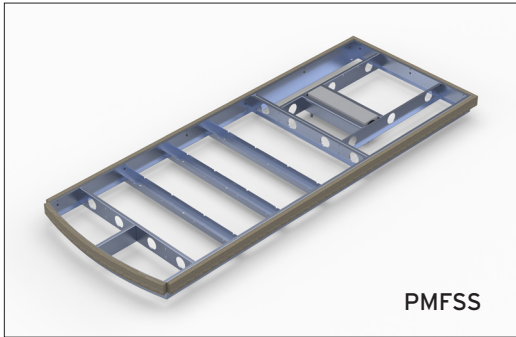

PMFSS

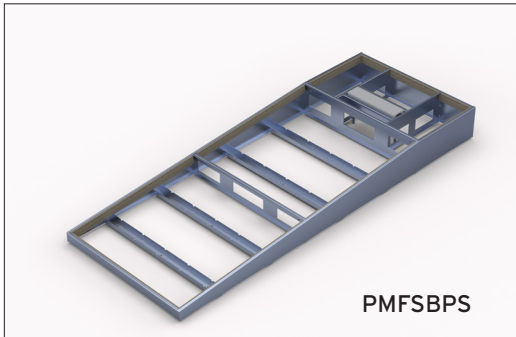

PMFSBPS

## Pitching Mound Forming Systems

### Product Overview

- Designed specifically for permanent synthetic infill turf installations
- Pre-engineered concrete forming system eliminates complex hand-forming
- Meets all rules and regulations for mound diameter, height, and slope
- Pitching rubber height adjustment, drainage, and turf attachment ledges
- Replaceable synthetic infill turf center section
- Bolt-together aluminum construction with rebar anchoring provisions
- Superior stability and longevity versus compacted stone alternatives
- Synthetic infill turf to be provided and installed by others on site
- Includes replaceable Schutt® four-sided professional pitching rubber (SHBBPB)
- US Patent Pending



Item Number	Product Description
PMFSB	Baseball Pitching Mound Forming System
PMFSS	Softball Pitching Mound Forming System
PMFSBPS	Bullpen Pitching Mound Forming System - Single
PMFSBPD	Bullpen Pitching Mound Forming System - Double
PMFSBPT	Bullpen Pitching Mound Forming System - Triple

# INNOVATIONS FOR EASE & ACCURACY

## Batter's Box Forming Systems

### Product Overview

- Designed specifically for permanent synthetic infill turf installations
- Pre-engineered concrete forming system eliminates complex hand-forming
- Home plate height adjustment, drainage, and turf attachment ledges
- Bolt-together aluminum construction with rebar anchoring provisions
- Superior stability and longevity versus compacted stone alternatives
- Synthetic infill turf to be provided and installed by others on site
- Includes replaceable Schutt® Hollywood Bury All Home Plate (SHSRHP)
- US Patent Pending

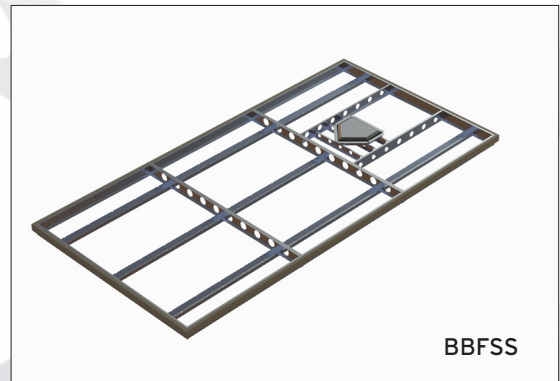
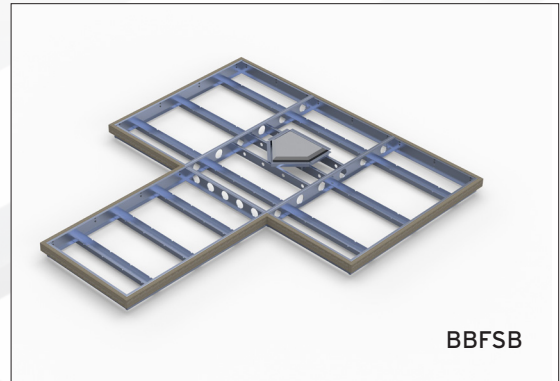

Item Number	Product Description
BBFSB	Baseball Batter's Box Forming System
BBFSS	Softball Batter's Box Forming System



# Porta-Pitch Seasonal Pitching Mound

## Product Overview

- Official size seasonal pitching mounds ideal for multi-use facilities!
- Available with synthetic turf or clay center section
- Optional clay center strip provides traditional feel and performance
- Sectional design and wheel / hitch system make it easy to transform field
- Meets all rules and regulations for size, height, and slope
- Includes official 4-sided pitching rubber
- Little League and bullpen models now available!

Item Number	Product Description
PPLLBIT	Seasonal Little League pitching mound, brown synthetic infill turf - 10' diameter
PPLRCIT	Seasonal Little League pitching mound, red clay synthetic infill turf - 10' diameter
PPLGIT	Seasonal Little League pitching mound, green synthetic infill turf - 10' diameter
PPBIT	Seasonal baseball pitching mound, brown synthetic infill turf - 18' diameter
PPB	Seasonal baseball pitching mound, clay center section and brown synthetic turf - 18' diameter
PPRCIT	Seasonal baseball pitching mound, red clay synthetic infill turf - 18' diameter
PPRC	Seasonal baseball pitching mound, clay center section and red clay synthetic turf - 18' diameter
PPGIT	Seasonal baseball pitching mound, green synthetic infill turf - 18' diameter
PPG	Seasonal baseball pitching mound, clay center section and green synthetic turf - 18' diameter
PPBPRBIT	Seasonal bullpen mound, brown synthetic turf pitching area
PPBPRB	Seasonal bullpen mound, clay pitching area with brown synthetic turf
PPDBPRBIT	Seasonal double bullpen mound, brown synthetic infill turf
PPBPRCIT	Seasonal bullpen mound, red clay synthetic turf pitching area
PPBPRC	Seasonal bullpen mound, clay pitching area with red clay synthetic turf
PPDBPRCIT	Double bullpen mound, red synthetic infill turf
PPBGIT	Seasonal bullpen mound, green synthetic infill turf pitching area
PPBPG	Seasonal bullpen mound, clay pitching area with green synthetic turf
PPDBPGIT	Double bullpen mound, red synthetic infill turf



Synthetic Turf Provided By and Installed By Others

**Patent Pending**

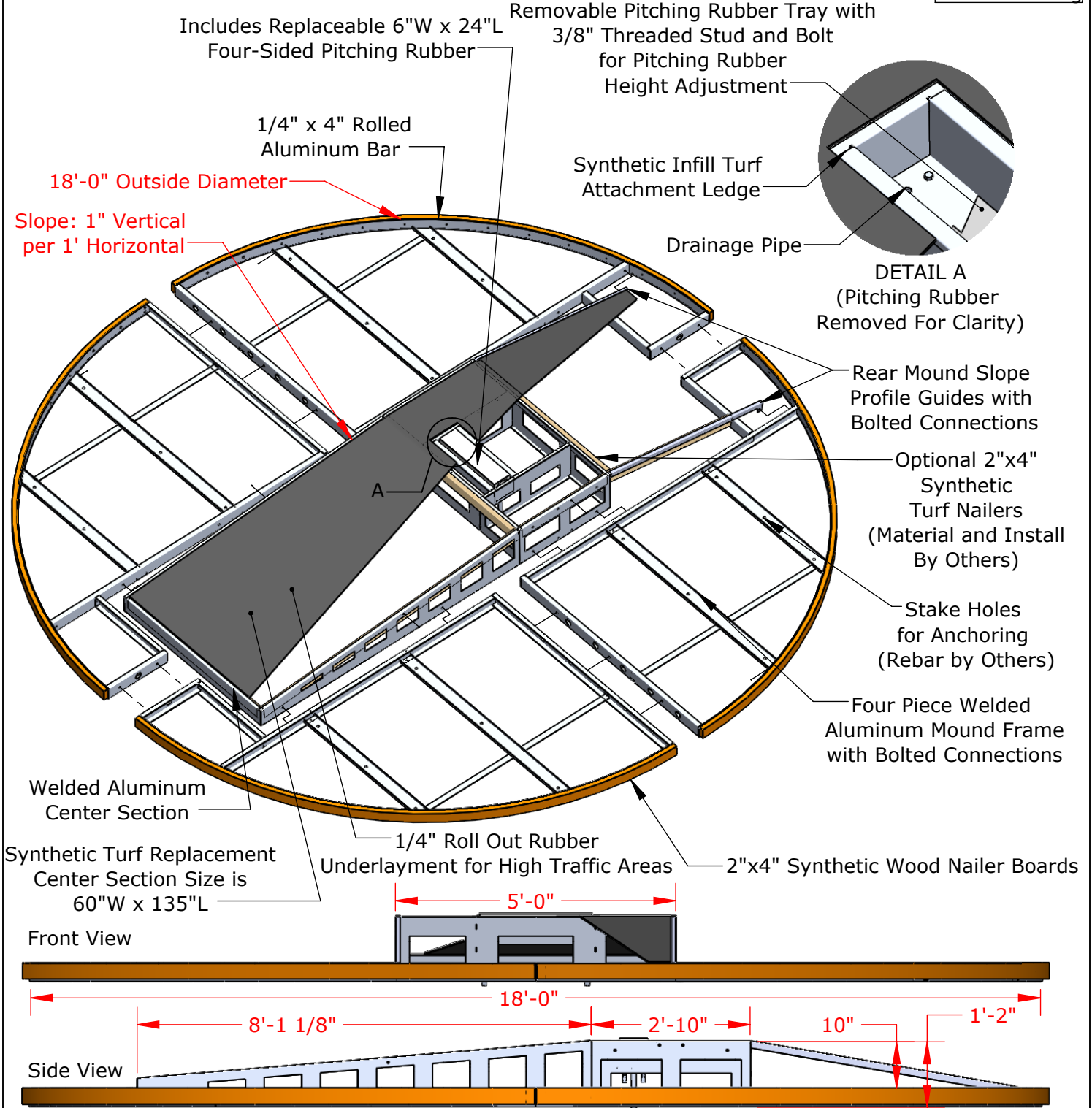

**PROPRIETARY AND CONFIDENTIAL**

THE INFORMATION CONTAINED IN THIS DRAWING IS THE SOLE PROPERTY OF SPORTSFIELD SPECIALTIES INC. ANY REPRODUCTION IN PART OR AS A WHOLE WITHOUT THE WRITTEN PERMISSION OF SPORTSFIELD SPECIALTIES INC. IS PROHIBITED.

**PMFSB**  
**Baseball Pitching Mound Forming System**

Not To Scale

Sportsfield Specialties Inc 104594.1-221025

Patent Pending

Synthetic Turf Provided By and Installed By Others

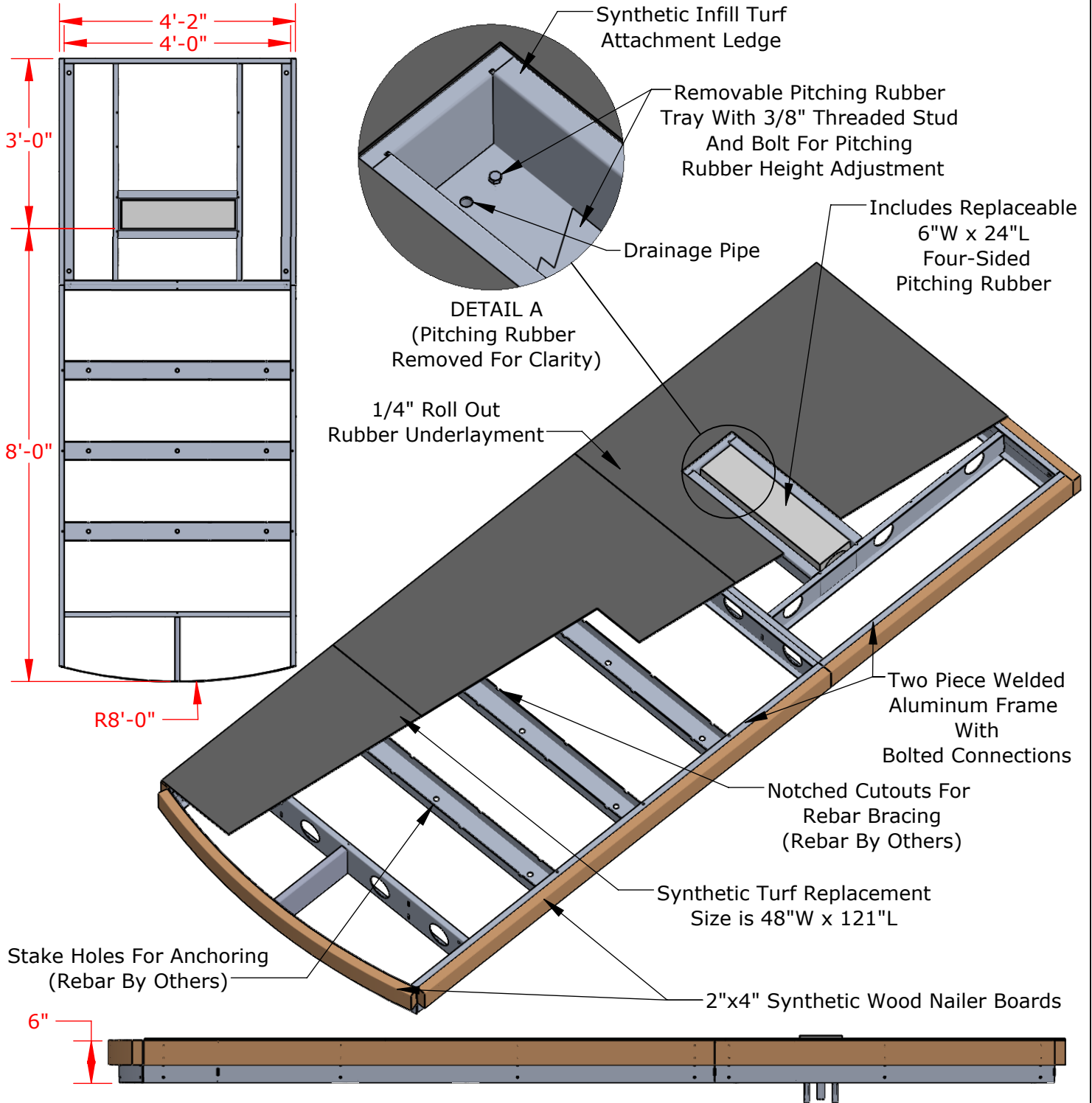

PROPRIETARY AND CONFIDENTIAL

THE INFORMATION CONTAINED IN THIS DRAWING IS THE SOLE PROPERTY OF SPORTSFIELD SPECIALTIES INC. ANY REPRODUCTION IN PART OR AS A WHOLE WITHOUT THE WRITTEN PERMISSION OF SPORTSFIELD SPECIALTIES INC. IS PROHIBITED.

# PMFSS Softball Pitching Mound Forming System

Not To Scale

Sportsfield Specialties Inc 104601.1-221025



SYNTHETIC TURF IMAGE

MEETS AND/OR EXCEEDS ALL  
 MLB, NCAA AND NFHS  
 SPECIFICATIONS

HILLTOPPER® MOUND  
 MEDIUM FIRM, POLYMER ENHANCED,  
 RED/BROWN CLAY

18'-0" OUTSIDE  
 DIAMETER

SLOPE: 1" VERTICAL PER  
 1' HORIZONTAL

REPLACEABLE SHBBPB FOUR SIDED  
 PROFESSIONAL PITCHING RUBBER  
 6"W x 24"L

BROWN YARN SYNTHETIC  
 TURF WITH RED CLAY THATCH LAYER

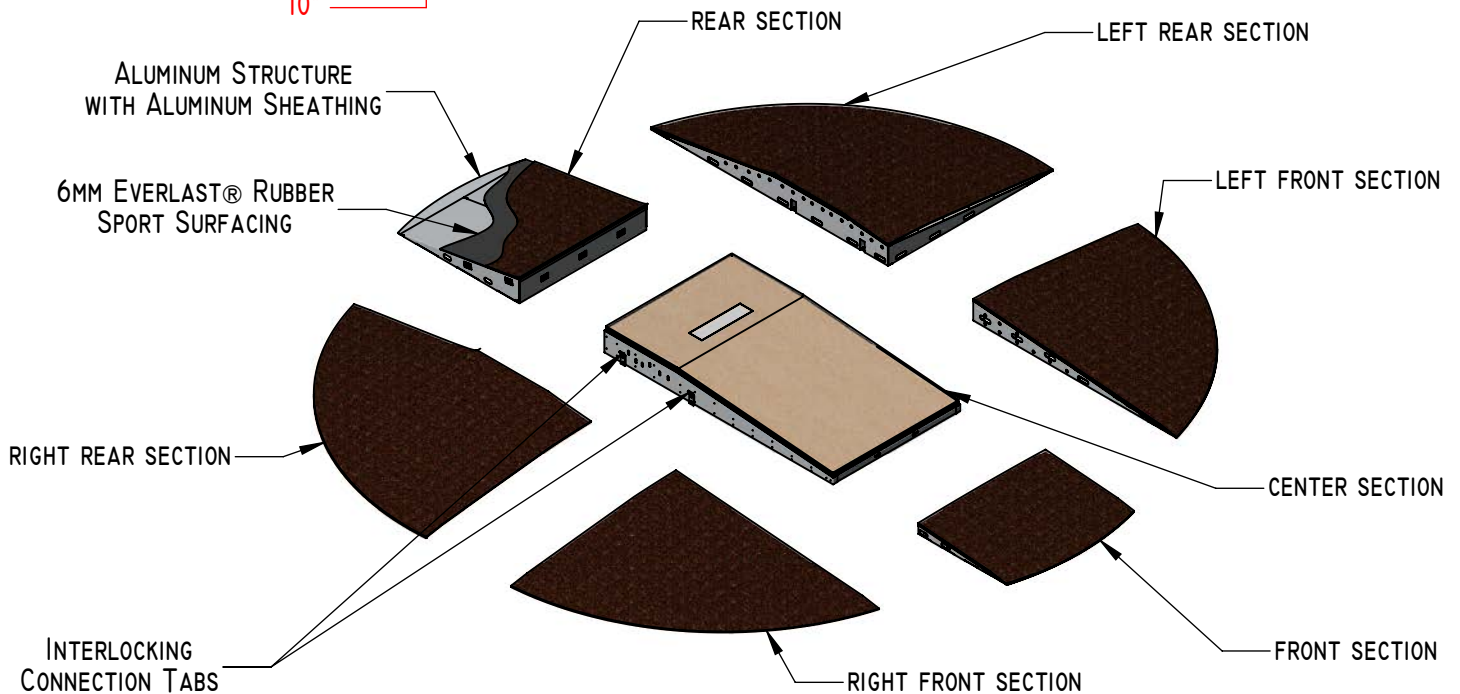

PROPRIETARY AND CONFIDENTIAL  
 THE INFORMATION CONTAINED IN THIS  
 DRAWING IS THE SOLE PROPERTY OF  
 SPORTSFIELD SPECIALTIES INC. ANY  
 REPRODUCTION IN PART OR AS A WHOLE  
 WITHOUT THE WRITTEN PERMISSION OF  
 SPORTSFIELD SPECIALTIES INC. IS  
 PROHIBITED.

**PPB (LGPRTPTCH-BR) BROWN  
 PORTA-PITCH PORTABLE BASEBALL PITCHER'S MOUND**

NOT TO SCALE

SPORTSFIELD SPECIALTIES INC 08042016



MEETS AND/OR EXCEEDS ALL  
 MLB, NCAA AND NFHS  
 SPECIFICATIONS

BROWN YARN SYNTHETIC  
 TURF WITH RED CLAY  
 THATCH LAYER  
 (INFILL SUPPLIED BY OTHERS)

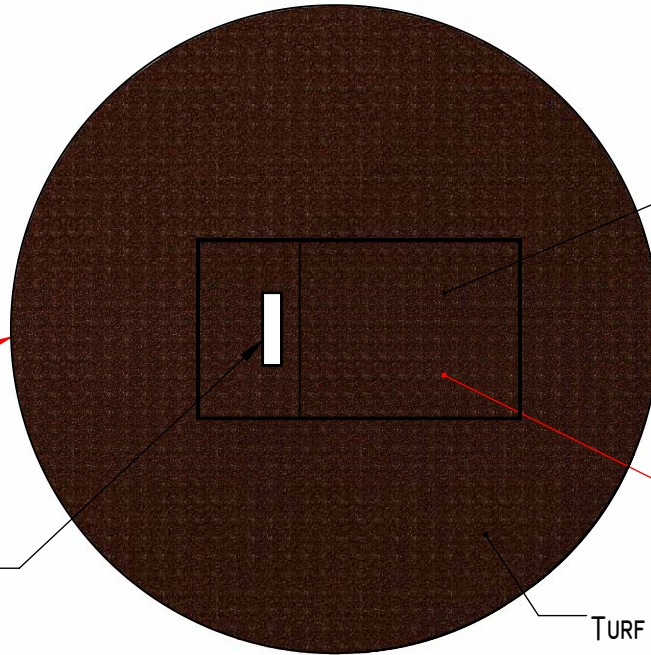

18'-0" OUTSIDE  
 DIAMETER

SLOPE: 1" VERTICAL PER  
 1' HORIZONTAL

REPLACEABLE SHBBPB FOUR SIDED  
 PROFESSIONAL PITCHING RUBBER  
 6"W x 24"L

BROWN YARN SYNTHETIC  
 TURF WITH RED CLAY THATCH LAYER

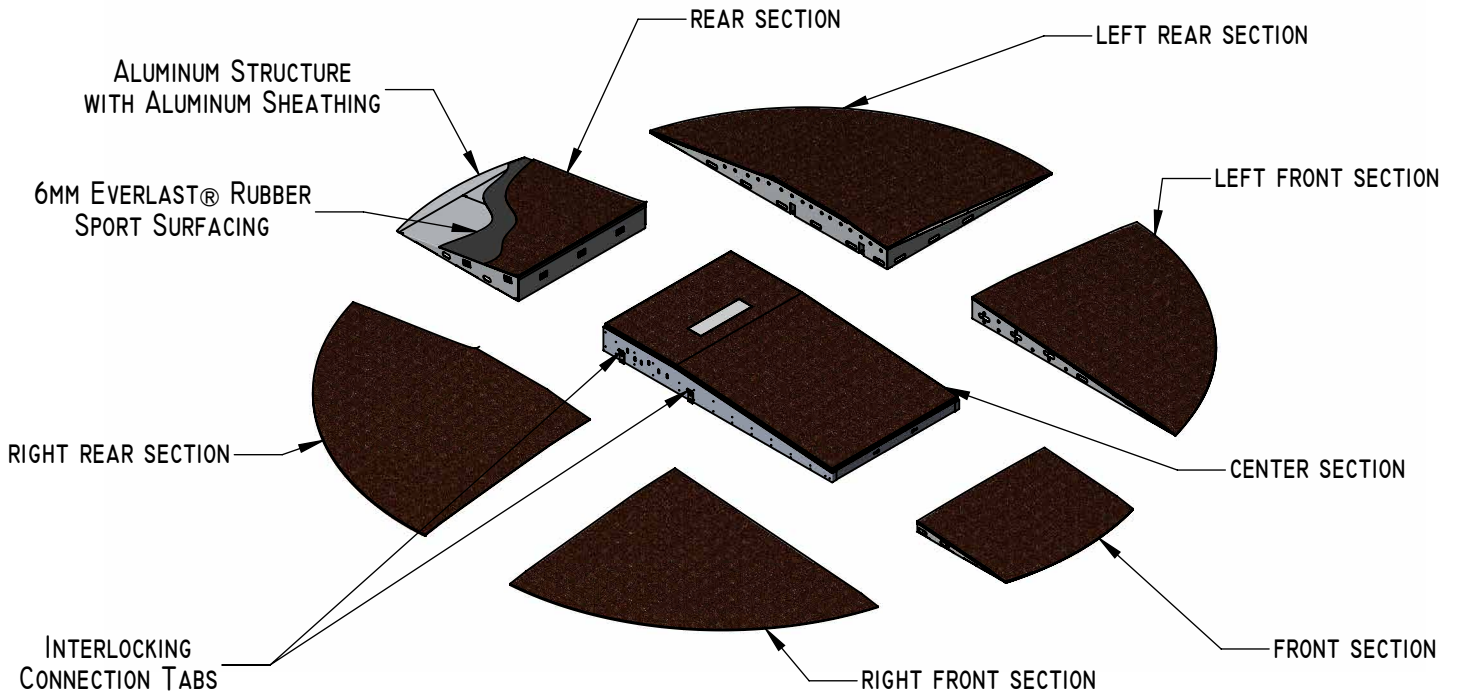

PROPRIETARY AND CONFIDENTIAL  
 THE INFORMATION CONTAINED IN THIS  
 DRAWING IS THE SOLE PROPERTY OF  
 SPORTSFIELD SPECIALTIES INC. ANY  
 REPRODUCTION IN PART OR AS A WHOLE  
 WITHOUT THE WRITTEN PERMISSION OF  
 SPORTSFIELD SPECIALTIES INC. IS  
 PROHIBITED.

**PPBIT (LGPRTPTCH-BR-SYN) BROWN INFILL TURF  
 PORTA-PITCH PORTABLE BASEBALL PITCHER'S MOUND**

NOT TO SCALE

SPORTSFIELD SPECIALTIES INC 08042016





MEETS AND/OR EXCEEDS ALL  
 MLB, NCAA AND NFHS  
 SPECIFICATIONS

HILLTOPPER® MOUND  
 MEDIUM FIRM, POLYMER ENHANCED,  
 RED/BROWN CLAY

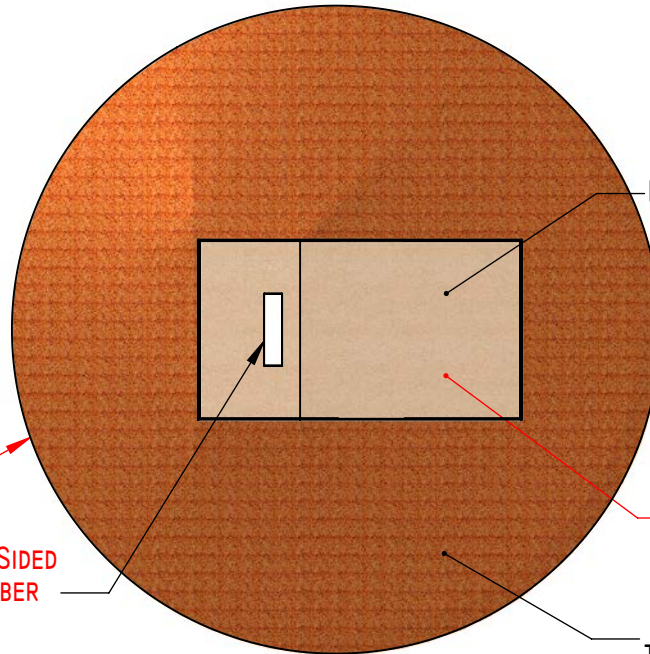

18'-0" OUTSIDE  
 DIAMETER

REPLACEABLE SHBBPB FOUR SIDED  
 PROFESSIONAL PITCHING RUBBER  
 6"W x 24"L

SLOPE: 1" VERTICAL PER  
 1' HORIZONTAL

RED CLAY SYNTHETIC  
 TURF WITH THATCH LAYER

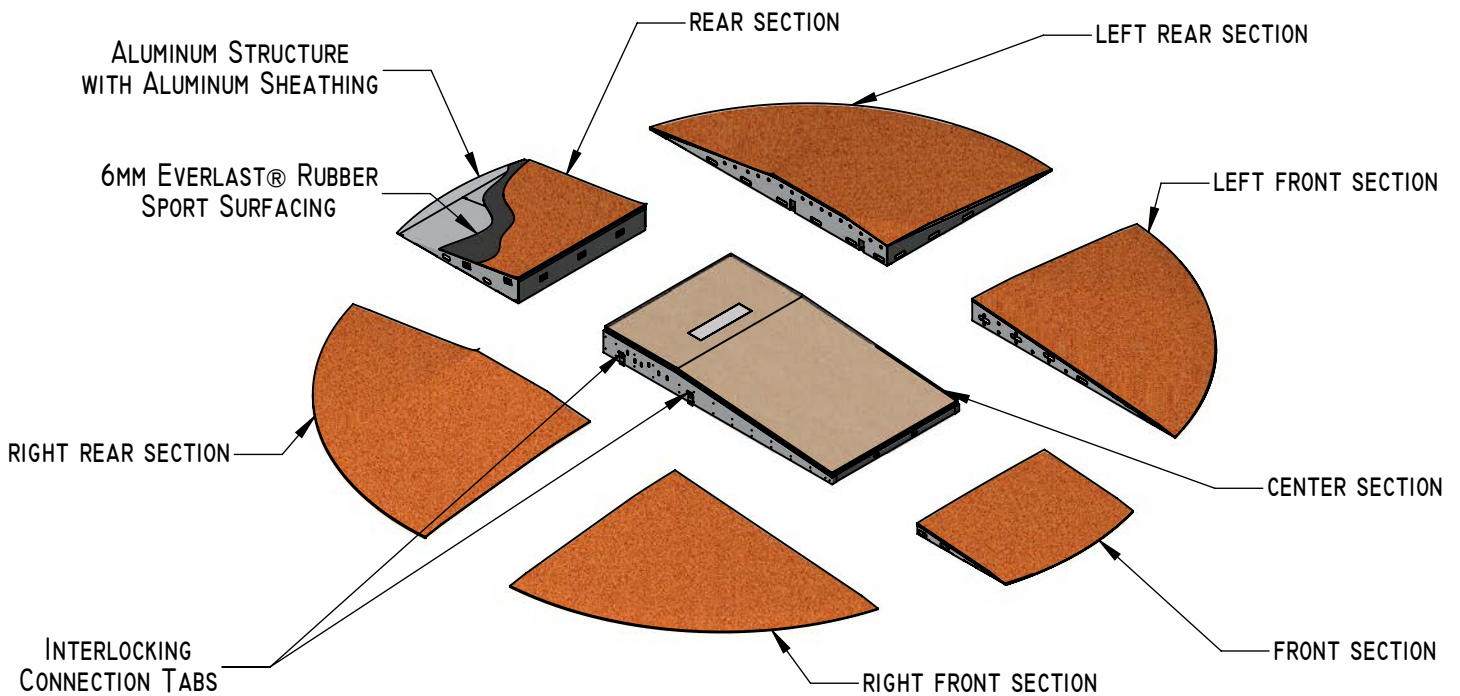
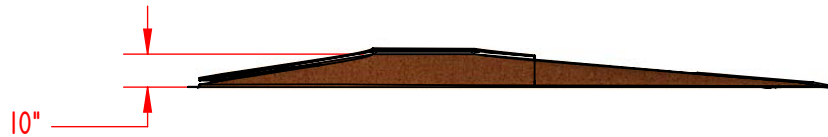

PROPRIETARY AND CONFIDENTIAL  
 THE INFORMATION CONTAINED IN THIS  
 DRAWING IS THE SOLE PROPERTY OF  
 SPORTSFIELD SPECIALTIES INC. ANY  
 REPRODUCTION IN PART OR AS A WHOLE  
 WITHOUT THE WRITTEN PERMISSION OF  
 SPORTSFIELD SPECIALTIES INC. IS  
 PROHIBITED.

**PPRC (LGPRTPTCH-RC) RED CLAY  
 PORTA-PITCH PORTABLE BASEBALL PITCHER'S MOUND**

NOT TO SCALE

SPORTSFIELD SPECIALTIES INC 08042016



MEETS AND/OR EXCEEDS ALL  
 MLB, NCAA AND NFHS  
 SPECIFICATIONS

RED CLAY SYNTHETIC  
 TURF WITH THATCH LAYER  
 (INFILL SUPPLIED BY OTHERS)

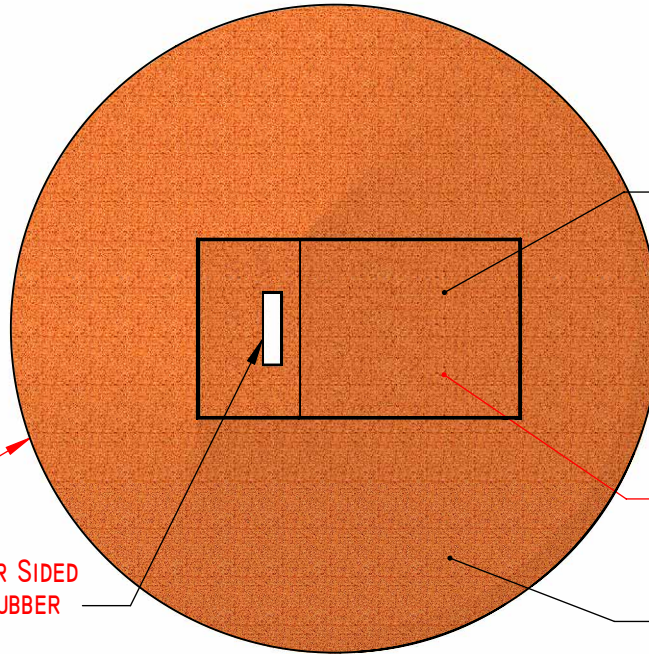

18'-0" OUTSIDE  
 DIAMETER

SLOPE: 1" VERTICAL PER  
 1' HORIZONTAL

REPLACEABLE SHBBPB FOUR SIDED  
 PROFESSIONAL PITCHING RUBBER  
 6"W x 24"L

RED CLAY SYNTHETIC  
 TURF WITH THATCH LAYER

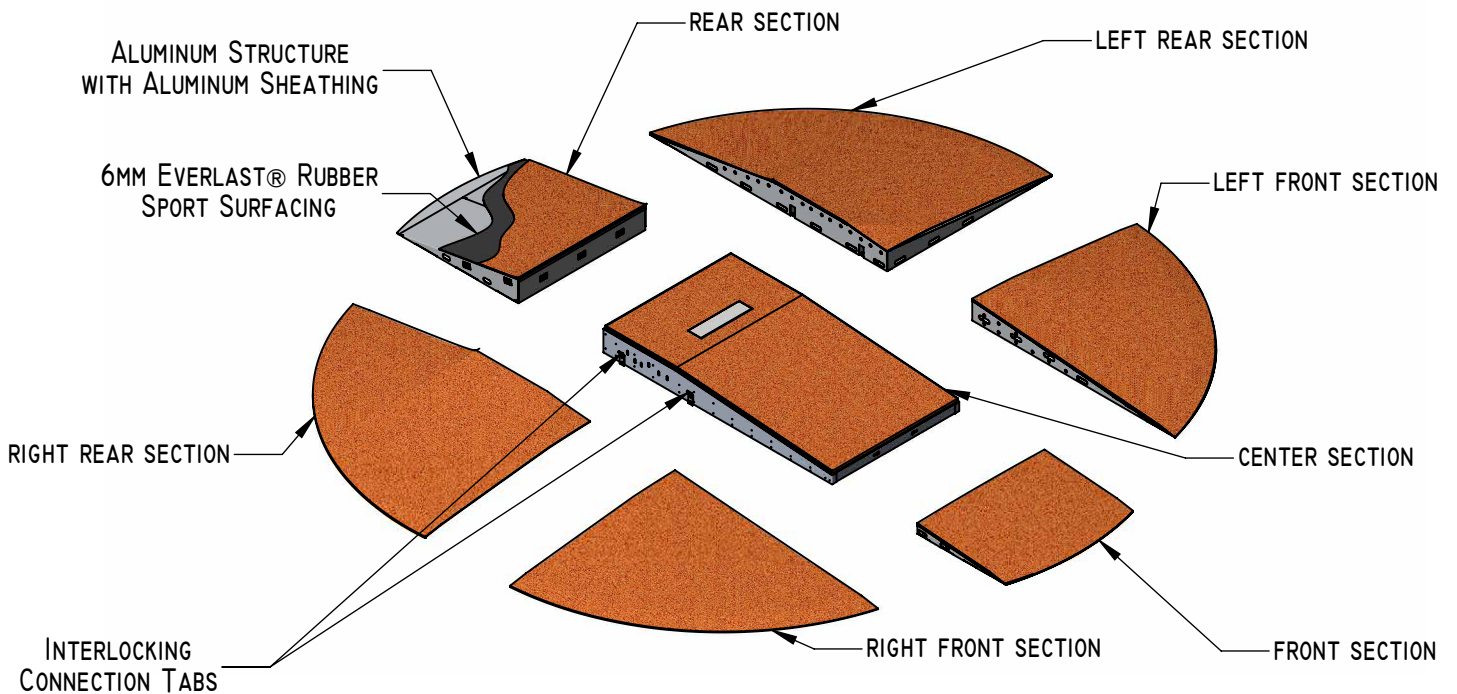
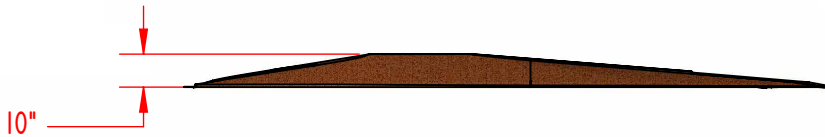

PROPRIETARY AND CONFIDENTIAL  
 THE INFORMATION CONTAINED IN THIS  
 DRAWING IS THE SOLE PROPERTY OF  
 SPORTSFIELD SPECIALTIES INC. ANY  
 REPRODUCTION IN PART OR AS A WHOLE  
 WITHOUT THE WRITTEN PERMISSION OF  
 SPORTSFIELD SPECIALTIES INC. IS  
 PROHIBITED.

**PPRCIT (LGPRTPTCH-RC-SYN) RED CLAY INFILL TURF  
 PORTA-PITCH PORTABLE BASEBALL PITCHER'S MOUND**

NOT TO SCALE

SPORTSFIELD SPECIALTIES INC 08042016



SYNTHETIC TURF IMAGE

MEETS AND/OR EXCEEDS ALL  
 MLB, NCAA AND NFHS  
 SPECIFICATIONS

HILLTOPPER® MOUND  
 MEDIUM FIRM, POLYMER ENHANCED,  
 RED/BROWN CLAY

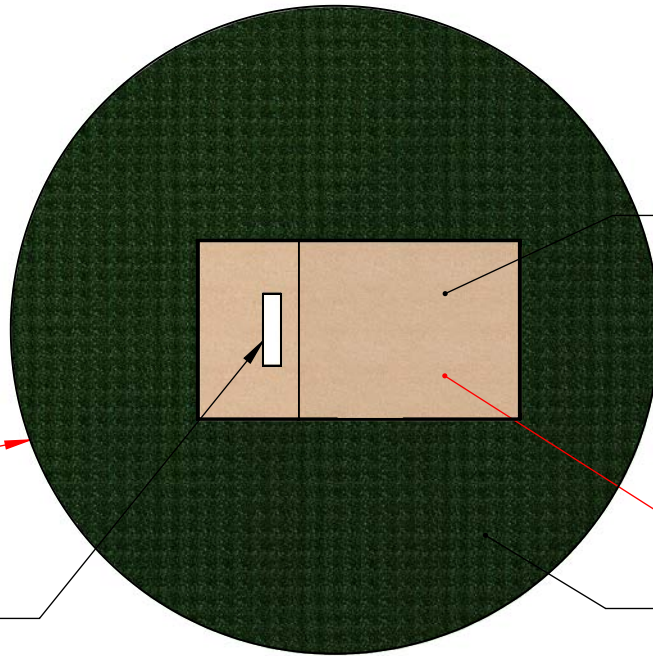

18'-0" OUTSIDE  
 DIAMETER

SLOPE: 1" VERTICAL PER  
 1' HORIZONTAL

REPLACEABLE SHBBPB FOUR SIDED  
 PROFESSIONAL PITCHING RUBBER  
 6"W X 24"L

GREEN SYNTHETIC  
 TURF WITH THATCH LAYER

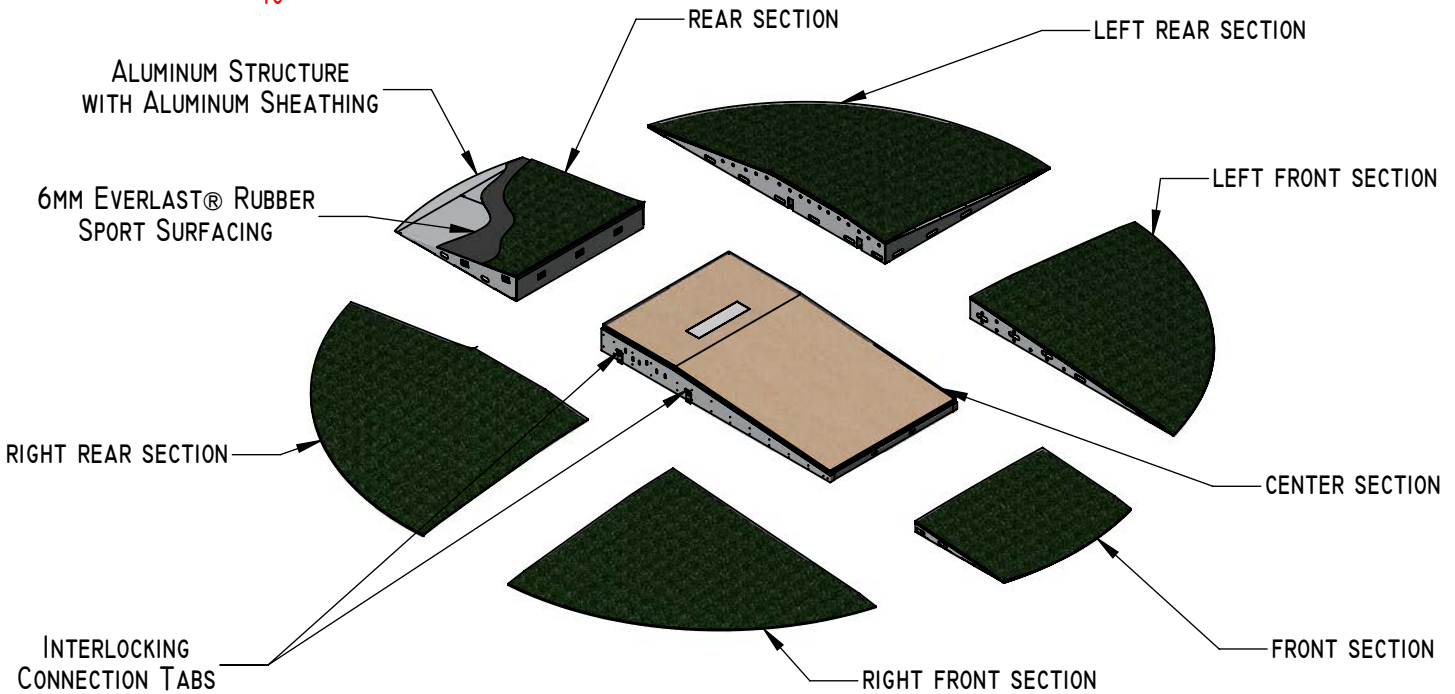

PROPRIETARY AND CONFIDENTIAL  
 THE INFORMATION CONTAINED IN THIS  
 DRAWING IS THE SOLE PROPERTY OF  
 SPORTSFIELD SPECIALTIES INC. ANY  
 REPRODUCTION IN PART OR AS A WHOLE  
 WITHOUT THE WRITTEN PERMISSION OF  
 SPORTSFIELD SPECIALTIES INC. IS  
 PROHIBITED.

**PPG (LGPRTPTCH-GR) GREEN  
 PORTA-PITCH PORTABLE BASEBALL PITCHER'S MOUND**

NOT TO SCALE

SPORTSFIELD SPECIALTIES INC 08042016



MEETS AND/OR EXCEEDS ALL  
 MLB, NCAA AND NFHS  
 SPECIFICATIONS

GREEN SYNTHETIC  
 TURF WITH THATCH LAYER  
 (INFILL SUPPLIED BY OTHERS)

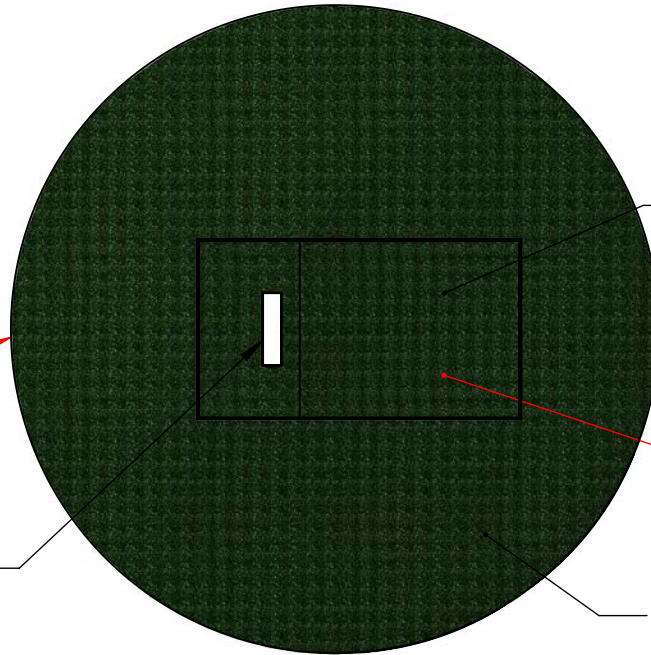

18'-0" OUTSIDE  
 DIAMETER

SLOPE: 1" VERTICAL PER  
 1' HORIZONTAL

REPLACEABLE SHBBPB FOUR SIDED  
 PROFESSIONAL PITCHING RUBBER  
 6"W x 24"L

GREEN SYNTHETIC  
 TURF WITH THATCH LAYER

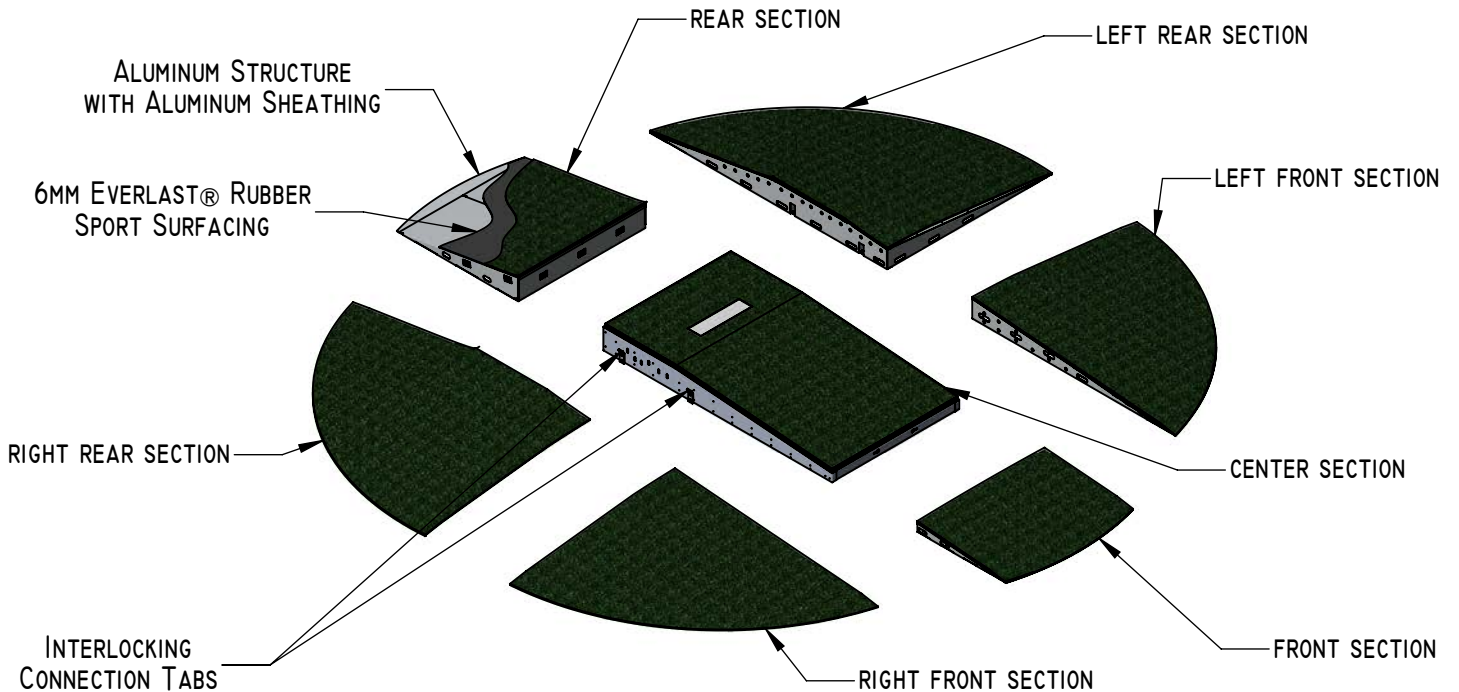

PROPRIETARY AND CONFIDENTIAL  
 THE INFORMATION CONTAINED IN THIS  
 DRAWING IS THE SOLE PROPERTY OF  
 SPORTSFIELD SPECIALTIES INC. ANY  
 REPRODUCTION IN PART OR AS A WHOLE  
 WITHOUT THE WRITTEN PERMISSION OF  
 SPORTSFIELD SPECIALTIES INC. IS  
 PROHIBITED.

**PPGIT (LGPRTPTCH-GR-SYN) GREEN INFILL TURF  
 PORTA-PITCH PORTABLE BASEBALL PITCHER'S MOUND**

NOT TO SCALE

SPORTSFIELD SPECIALTIES INC 08042016

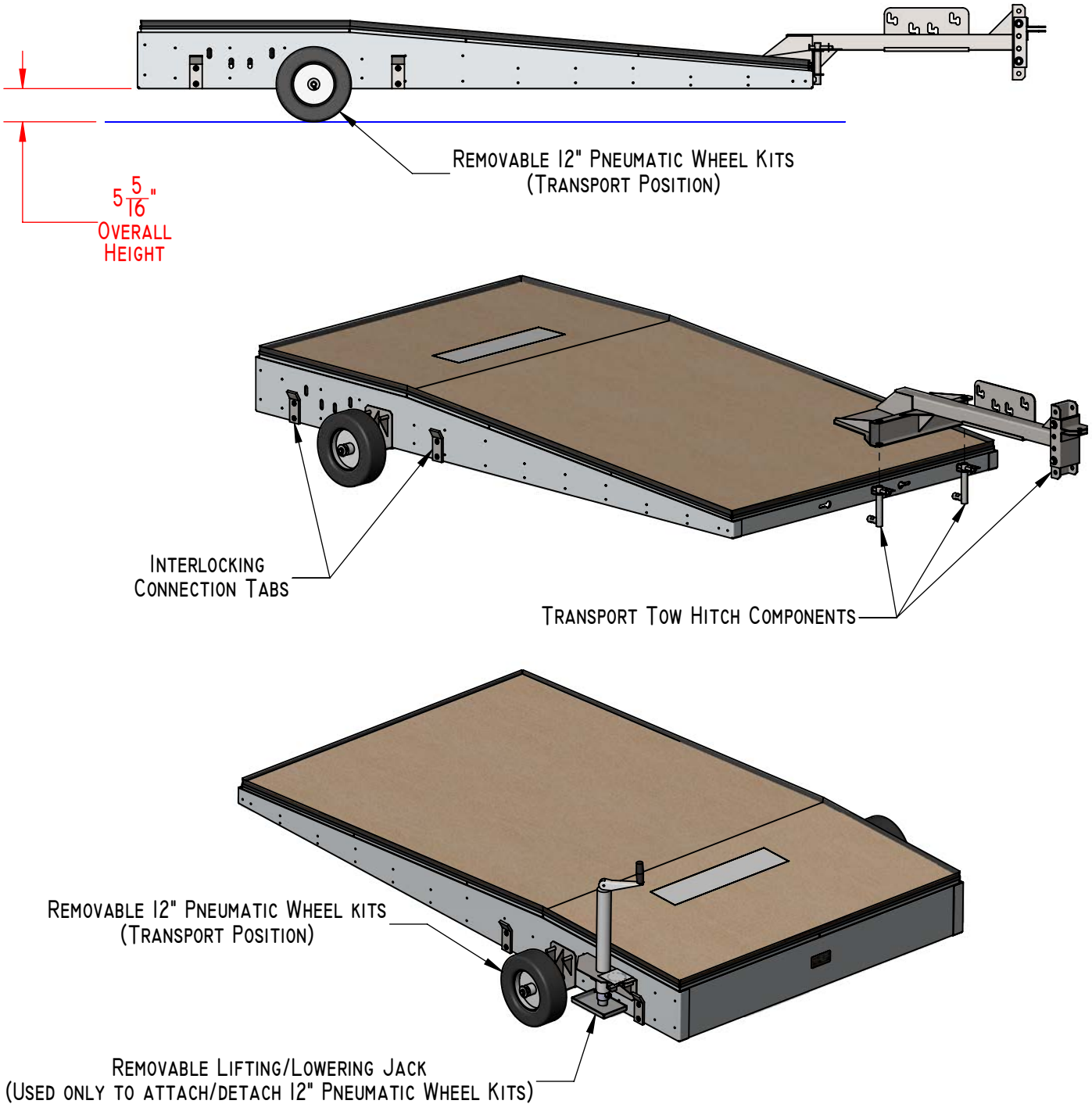

PROPRIETARY AND CONFIDENTIAL  
 THE INFORMATION CONTAINED IN THIS  
 DRAWING IS THE SOLE PROPERTY OF  
 SPORTSFIELD SPECIALTIES INC. ANY  
 REPRODUCTION IN PART OR AS A WHOLE  
 WITHOUT THE WRITTEN PERMISSION OF  
 SPORTSFIELD SPECIALTIES INC. IS  
 PROHIBITED.

**TRANSPORT TOW HITCH, WHEELS AND JACK  
 FOR PORTA-PITCH CENTER SECTION**

NOT TO SCALE

SPORTSFIELD SPECIALTIES INC 08162016

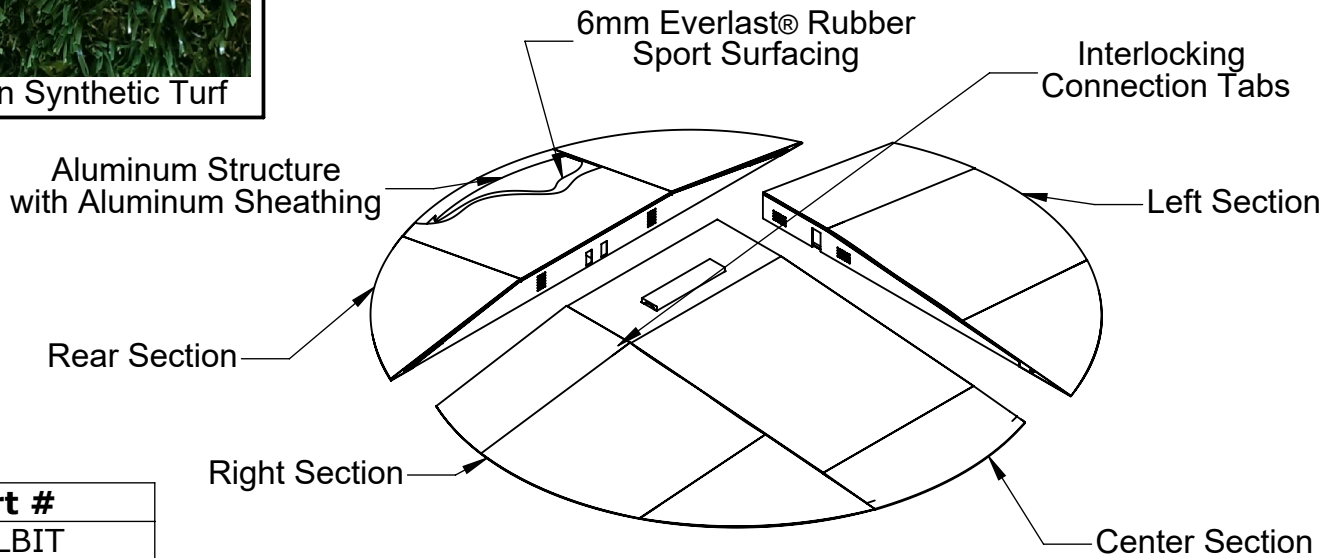
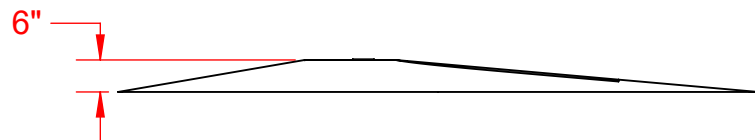
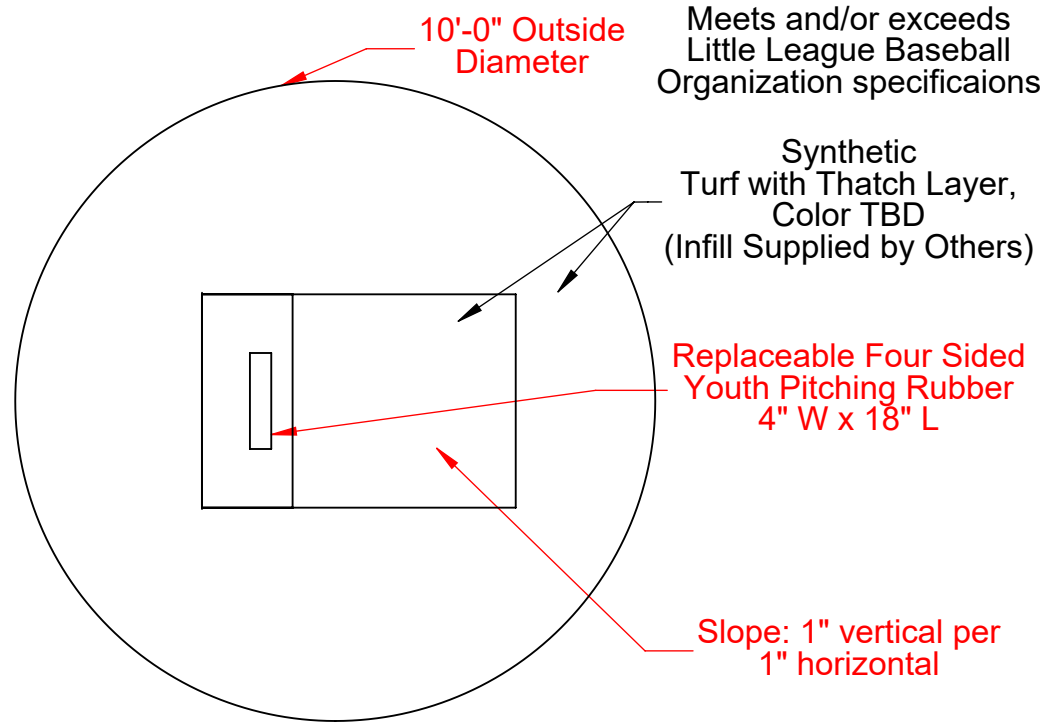
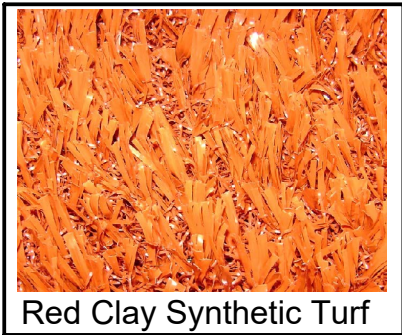

<b>Part #</b>
PPLLBIT
PPLLGIT
PPLLRCIT

**PROPRIETARY AND CONFIDENTIAL**

THE INFORMATION CONTAINED IN THIS DRAWING IS THE SOLE PROPERTY OF SPORTSFIELD SPECIALTIES INC. ANY REPRODUCTION IN PART OR AS A WHOLE WITHOUT THE WRITTEN PERMISSION OF SPORTSFIELD SPECIALTIES INC. IS PROHIBITED.

# Synthetic Turf Porta-Pitch Portable Little League Pitcher's Mound

Not To Scale

Sportsfield Specialties Inc 106743.0-230217

Synthetic Turf Provided By and Installed By Others

Includes Replaceable

**Patent Pending**

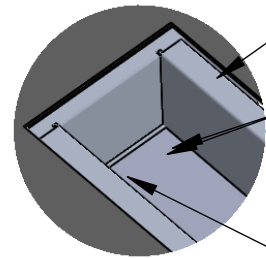

**DETAIL A**

(Pitching Rubber Removed For Clarity)

Synthetic Infill Turf Attachment Ledge  
Removable Pitching Rubber Tray With 3/8" Threaded Stud And Bolt For Pitching Rubber Height Adjustment  
Drainage Pipe

Stake Holes For Anchoring (Rebar By Others)

Notched Cutouts For Rebar Bracing (Rebar By Others)

2"x4" Synthetic Turf Nailers (Material And Install By Others)

6"W x 29"L Four-Sided Pitching Rubber

1/4" Roll Out Rubber Underlayment

A

Three Piece Welded Aluminum Frame With Bolted Connections

Synthetic Turf Replacement Size is 58"W x 152"L

Available As A Single, Double Or Triple Bullpen Mound Configuration

Knock Out Perforations For Concrete Flow In Multi-Mound Systems

Front And Rear Spacing Brackets For Multi-Mound Systems, Adjustable From 5' to 10' (C To C Of Pitching Rubbers)

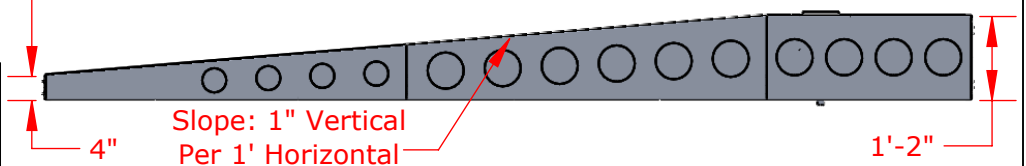
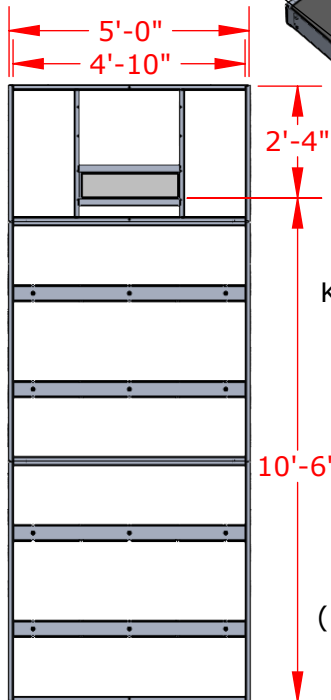

Part No.	Description
PMFSBPS	Single Mound Forming System
PMFSBPD	Double Mound Forming System
PMFSBPT	Triple Mound Forming System

**PROPRIETARY AND CONFIDENTIAL**

THE INFORMATION CONTAINED IN THIS DRAWING IS THE SOLE PROPERTY OF SPORTSFIELD SPECIALTIES INC. ANY REPRODUCTION IN PART OR AS A WHOLE WITHOUT THE WRITTEN PERMISSION OF SPORTSFIELD SPECIALTIES INC. IS PROHIBITED.

# Bullpen Pitching Mound Forming System

Not To Scale

Sportsfield Specialties Inc 104595.1-221025



Synthetic Turf Image

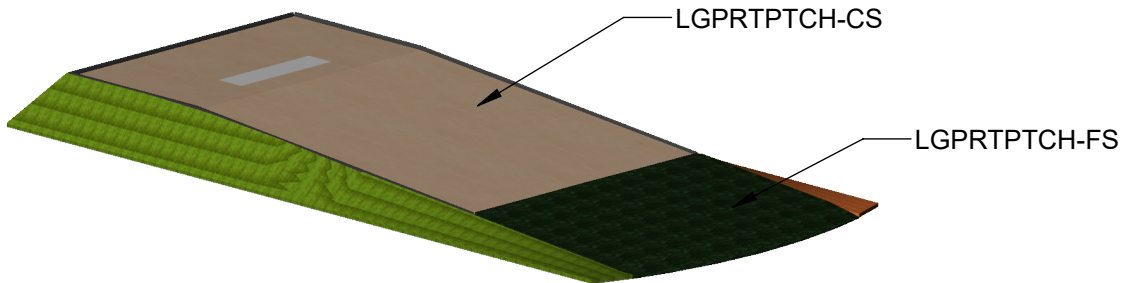
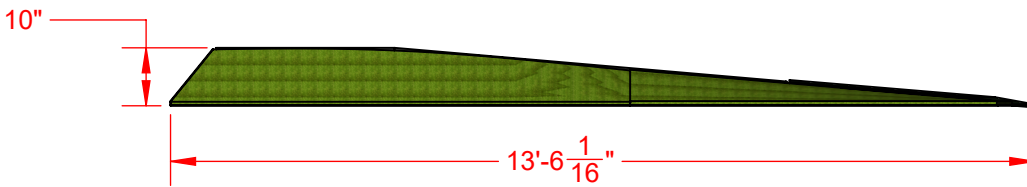
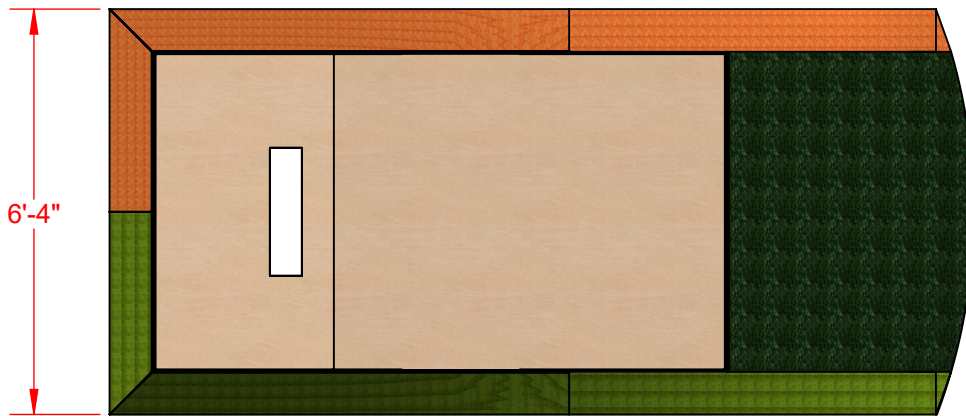

**PROPRIETARY AND CONFIDENTIAL**

THE INFORMATION CONTAINED IN THIS DRAWING IS THE SOLE PROPERTY OF SPORTSFIELD SPECIALTIES INC. ANY REPRODUCTION IN PART OR AS A WHOLE WITHOUT THE WRITTEN PERMISSION OF SPORTSFIELD SPECIALTIES INC. IS PROHIBITED.

**PPBPB Porta-Pitch Pitcher's Bullpen Mound**

Not To Scale

Sportsfield Specialties Inc 105613.1-221212





Synthetic Turf Image

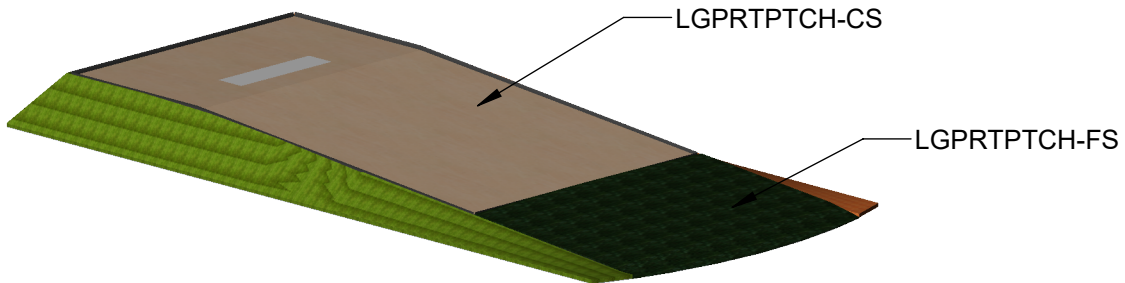
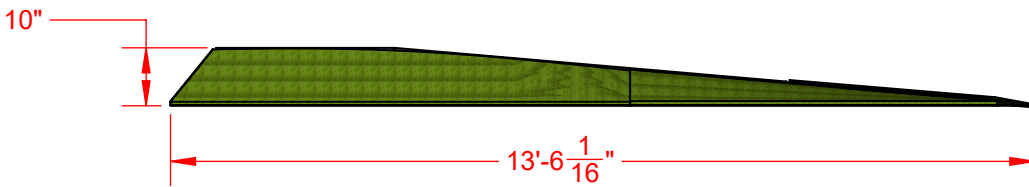
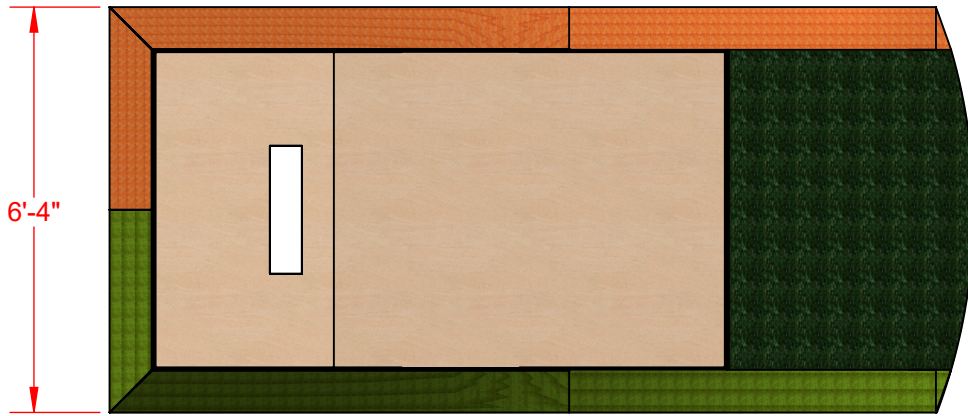

**PROPRIETARY AND CONFIDENTIAL**

THE INFORMATION CONTAINED IN THIS DRAWING IS THE SOLE PROPERTY OF SPORTSFIELD SPECIALTIES INC. ANY REPRODUCTION IN PART OR AS A WHOLE WITHOUT THE WRITTEN PERMISSION OF SPORTSFIELD SPECIALTIES INC. IS PROHIBITED.

**PPBPRC Porta-Pitch Pitcher's Bullpen Mound**

Not To Scale

Sportsfield Specialties Inc 105618.1-221212



Synthetic Turf Image

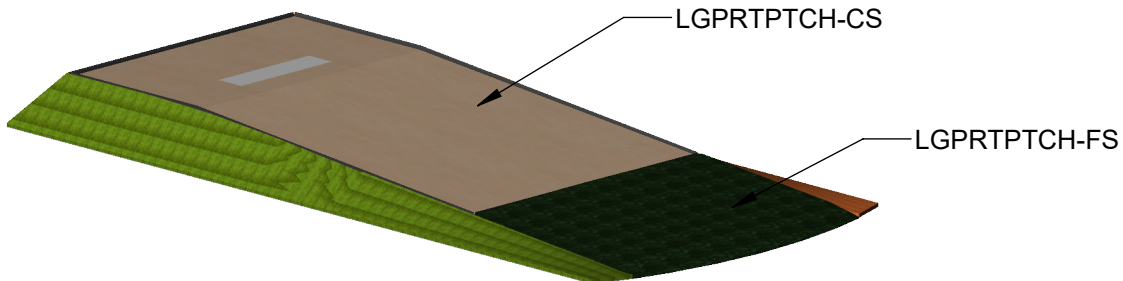
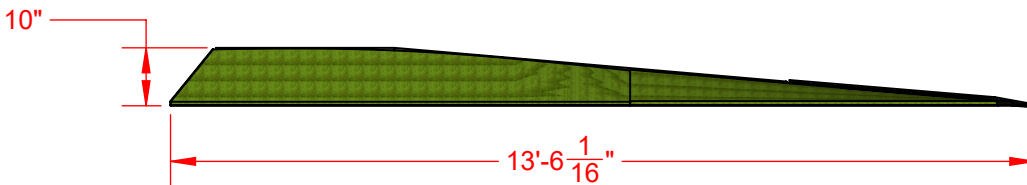
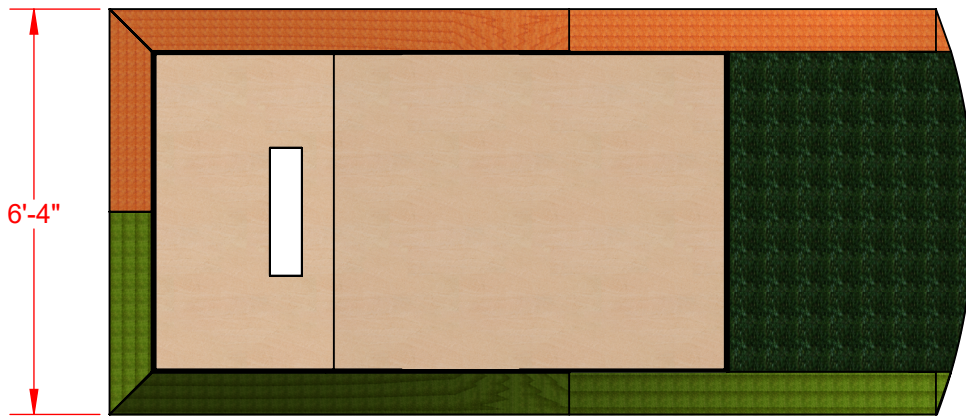

**PROPRIETARY AND CONFIDENTIAL**

THE INFORMATION CONTAINED IN THIS DRAWING IS THE SOLE PROPERTY OF SPORTSFIELD SPECIALTIES INC. ANY REPRODUCTION IN PART OR AS A WHOLE WITHOUT THE WRITTEN PERMISSION OF SPORTSFIELD SPECIALTIES INC. IS PROHIBITED.

**PPBPG Porta-Pitch Pitcher's Bullpen Mound**

Not To Scale

Sportsfield Specialties Inc 105621.1-221212



Brown Synthetic Turf



Red Clay Synthetic Turf



Green Synthetic Turf

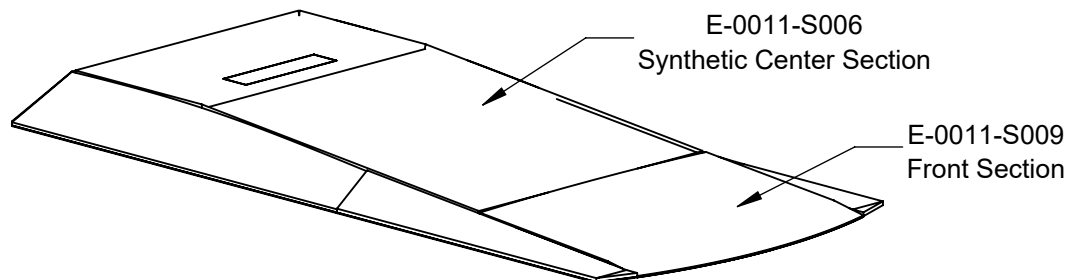
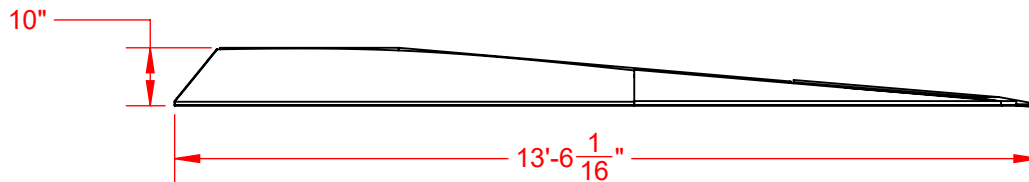
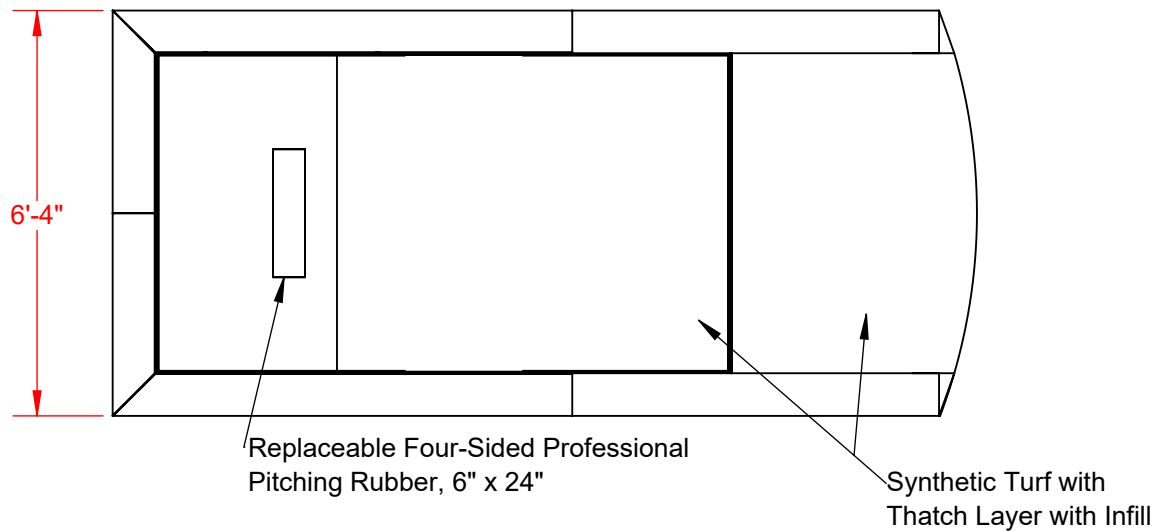

<b>Part #</b>
PPBPBIT
PPBPRCIT
PPBPGIT

**PROPRIETARY AND CONFIDENTIAL**

THE INFORMATION CONTAINED IN THIS DRAWING IS THE SOLE PROPERTY OF SPORTSFIELD SPECIALTIES INC. ANY REPRODUCTION IN PART OR AS A WHOLE WITHOUT THE WRITTEN PERMISSION OF SPORTSFIELD SPECIALTIES INC. IS PROHIBITED.

## Synthetic Turf Porta-Pitch Pitcher's BullPen Mound

Not To Scale

Sportsfield Specialties Inc 106742.0-230217

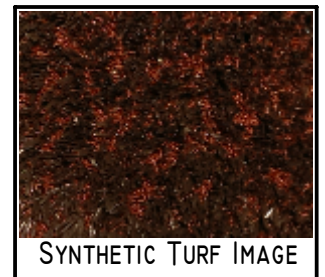
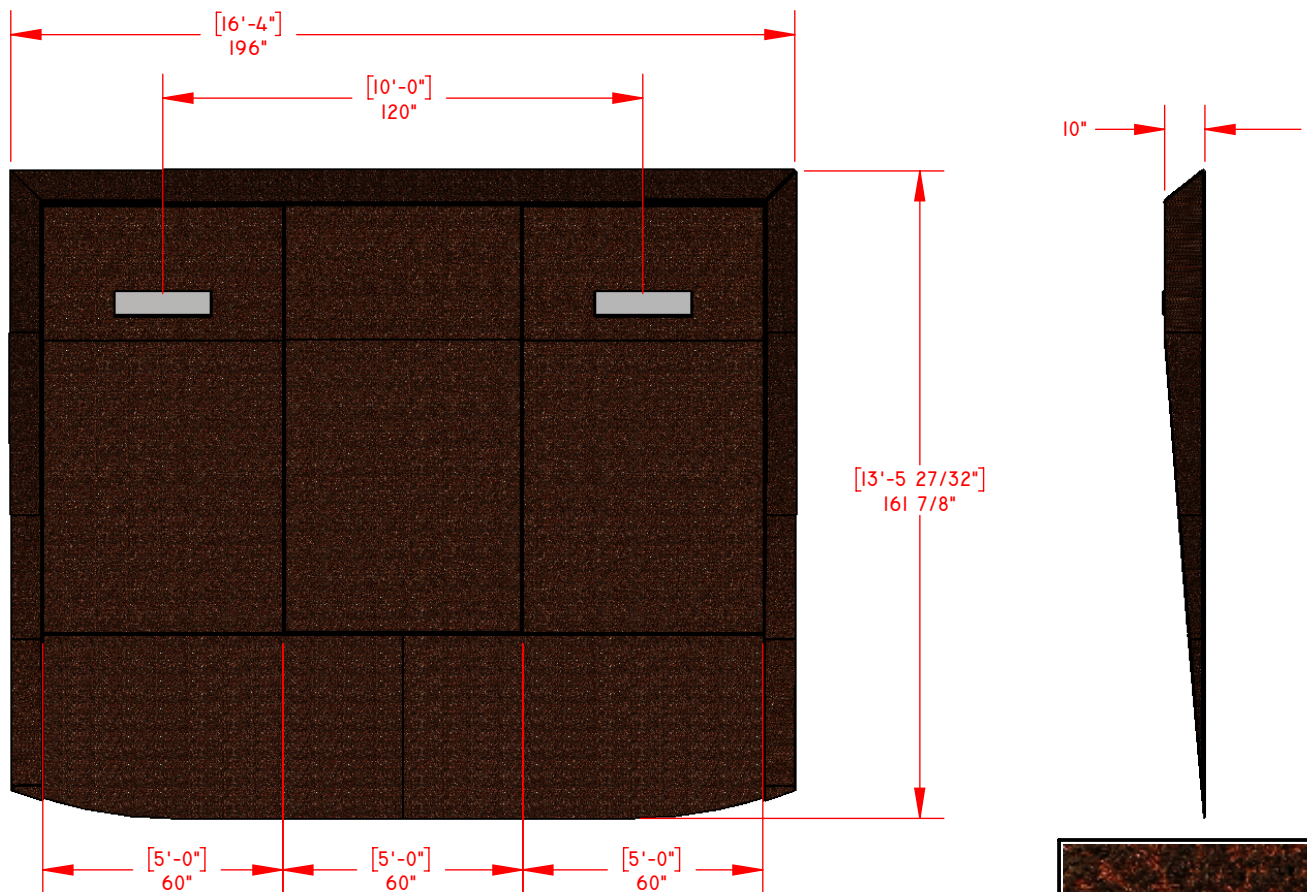
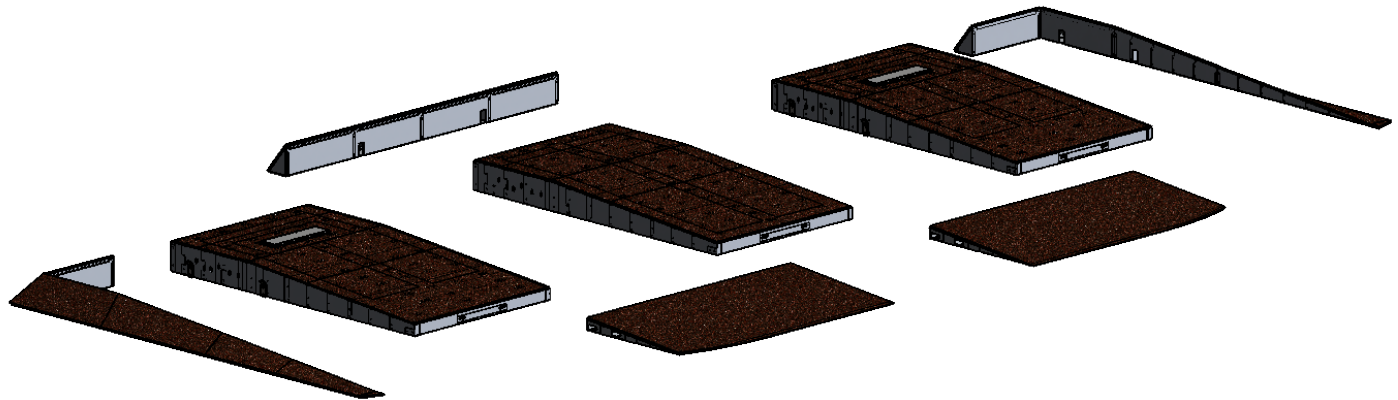

**PROPRIETARY AND CONFIDENTIAL**

THE INFORMATION CONTAINED IN THIS DRAWING IS THE SOLE PROPERTY OF SPORTSFIELD SPECIALTIES INC. ANY REPRODUCTION IN PART OR AS A WHOLE WITHOUT THE WRITTEN PERMISSION OF SPORTSFIELD SPECIALTIES INC. IS PROHIBITED.

**PPDBPBIT**  
**DOUBLE BULLPEN PORTA-PITCH SYNTHETIC MOUND**

NOT TO SCALE

SPORTSFIELD SPECIALTIES INC 03082019

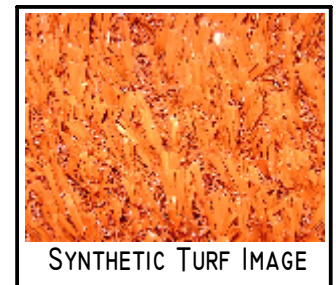
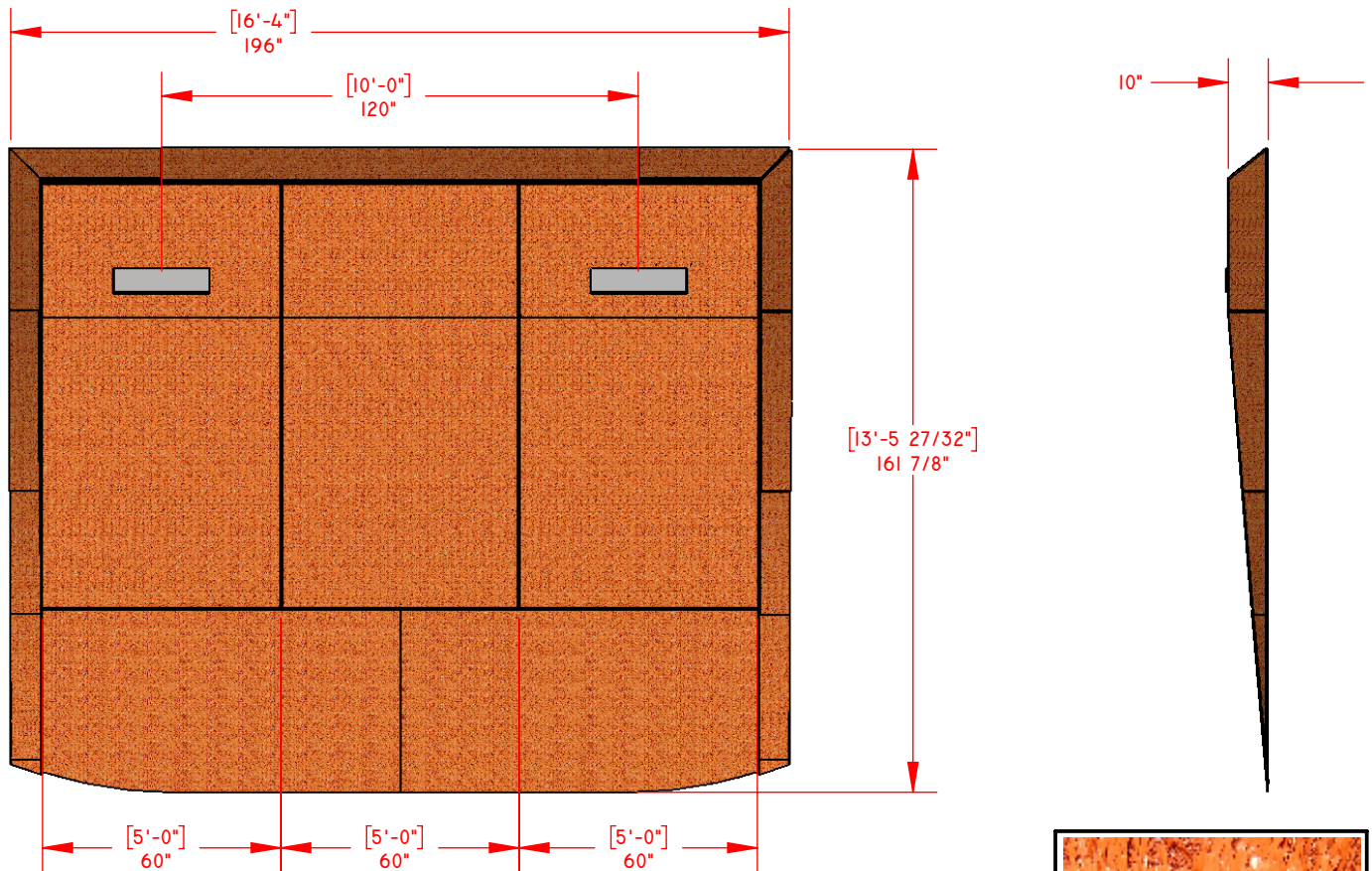
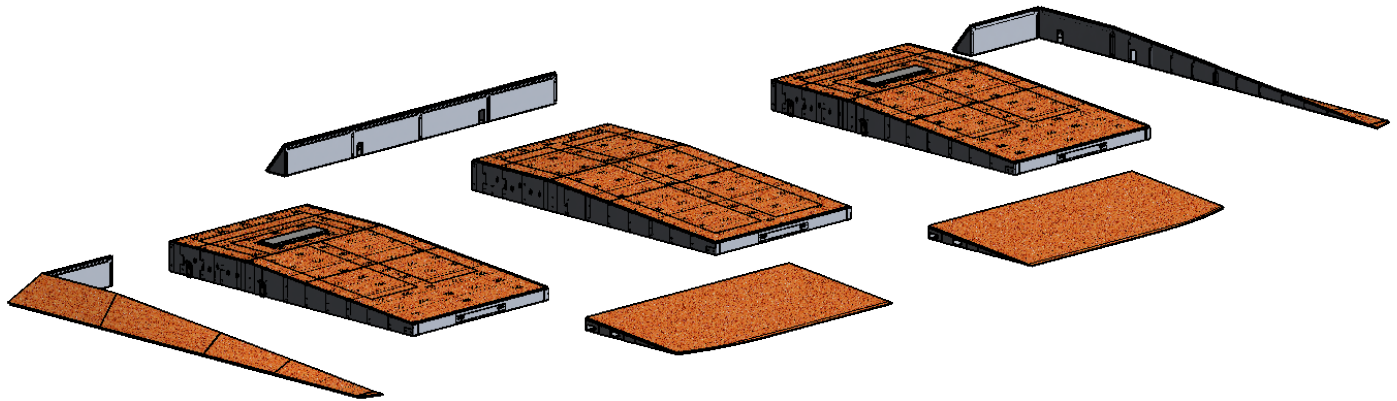

**PROPRIETARY AND CONFIDENTIAL**

THE INFORMATION CONTAINED IN THIS DRAWING IS THE SOLE PROPERTY OF SPORTSFIELD SPECIALTIES INC. ANY REPRODUCTION IN PART OR AS A WHOLE WITHOUT THE WRITTEN PERMISSION OF SPORTSFIELD SPECIALTIES INC. IS PROHIBITED.

**PPDBPRCIT**  
**DOUBLE BULLPEN PORTA-PITCH SYNTHETIC MOUND**

NOT TO SCALE

SPORTSFIELD SPECIALTIES INC 03082019

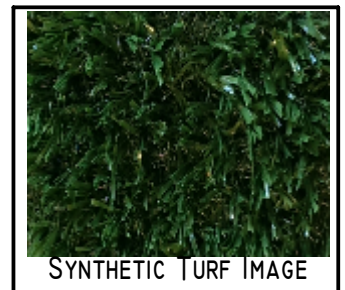
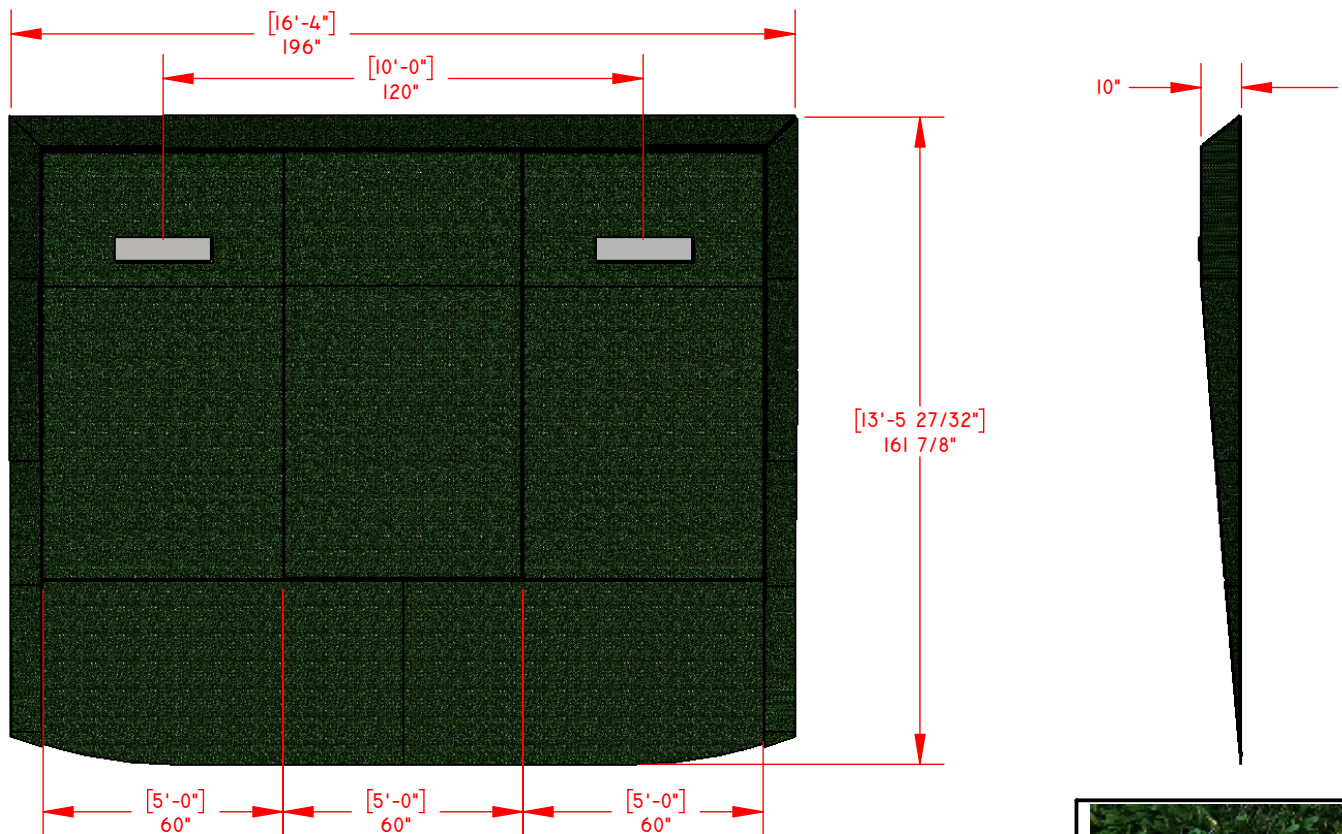
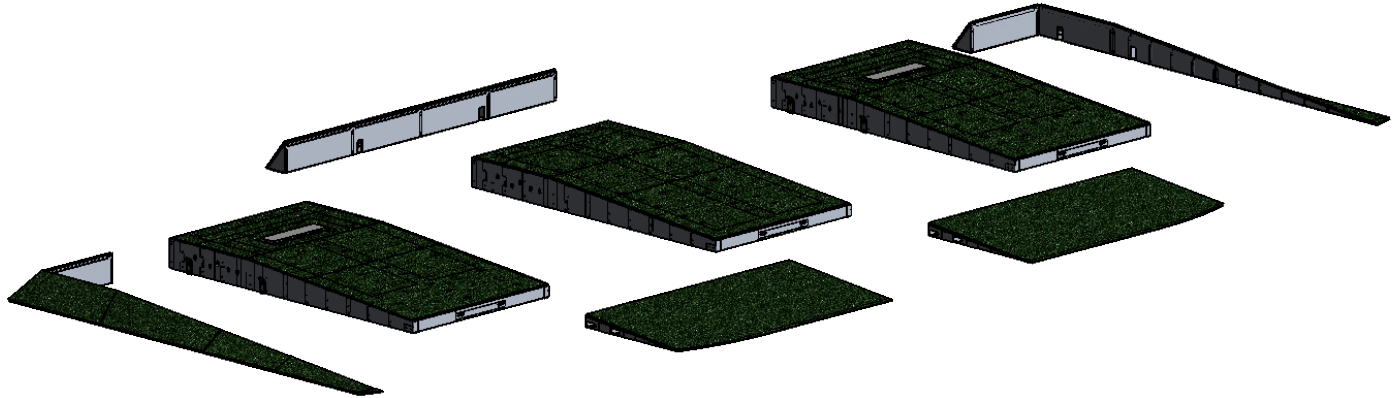

**PROPRIETARY AND CONFIDENTIAL**

THE INFORMATION CONTAINED IN THIS DRAWING IS THE SOLE PROPERTY OF SPORTSFIELD SPECIALTIES INC. ANY REPRODUCTION IN PART OR AS A WHOLE WITHOUT THE WRITTEN PERMISSION OF SPORTSFIELD SPECIALTIES INC. IS PROHIBITED.

**PPDBPGIT**  
**DOUBLE BULLPEN PORTA-PITCH SYNTHETIC MOUND**

NOT TO SCALE

SPORTSFIELD SPECIALTIES INC 03082019