



www.sportsfield.com | 888-975-3343

*Excellence from
Design to Installation*



Long / Triple Jump Pits & Accessories



Sportsfield Specialties, Inc. 41155 State Hwy 10. Delhi, NY 13753

JumpForm® Long / Triple Jump Sand Pit Forming Systems



Product Overview

- Sportsfield is the inventor and industry-leading provider of sand pit forming systems
- NEW! 1/4" recessed aluminum cover set designed specifically to reduce weight!
- Stay-in-place forming systems simplify installation and eliminate complex hand-forming
- All systems feature bolt-together aluminum construction with gusset reinforcement
- Prefabricated ninety-degree corner sections ensure accuracy and squareness
- Sand catcher models include exclusive integral drainage feature
- Forty-five degree beveled cover ledge design improves athlete safety
- Standard aluminum cover sets contain sand, prevent contamination, and improve safety
- Aluminum covers are recessed to accept synthetic track surfacing material
- U.S. patents #7,641,593; #8,186,125; #8,745,955

Item Number	Product Description
SPHSCVR	JumpForm® H.S. sand pit forming system with cover ledges - 3M x 7M
SPSCHS	JumpForm® H.S. sand pit forming system with sand catchers - 3M x 7M
SPCLHSDR	Dual JumpForm® H.S. sand pit forming system with cover ledges - 3M x 7M
SPSCHSDR	Dual JumpForm® H.S. sand pit forming system with sand catchers - 3M x 7M
SPHSCVR	JumpForm® H.S. sand pit aluminum cover set - 1/2" recess
SPHSCVRQ	JumpForm® H.S. sand pit aluminum cover set - 1/4" recess
SPCLCOL	JumpForm® college / World Athletics sand pit forming system with cover ledges - 3M x 9M
SPSCCOL	JumpForm® college / World Athletics sand pit forming system with sand catchers - 3M x 9M
SPCLCOLDR	Dual JumpForm® college / World Athletics sand pit forming system with cover ledges - 3M x 9M
SPSCCOLDR	Dual JumpForm® college / World Athletics sand pit forming system with sand catchers - 3M x 9M
SPCOLCVR	JumpForm® college / World Athletics sand pit aluminum cover set - 1/2" recess
SPCOLCVRQ	JumpForm® college / World Athletics sand pit aluminum cover set - 1/4" recess

Excellence from Design to Installation





Long / Triple Jump Take-Off Boards

Product Overview

- NEW textured polyboard combines enhanced traction with maximum durability
- Patented slide-on design eliminates exposed hardware from the jumping surface
- Synthetic polyboard material is guaranteed not to warp, splinter, or crack
- Integral 1" PVC drainage stub ensures positive drainage connection
- Choose between reversible insert or seasonal blanking lid systems
- 8", 12" and 16" models accommodate all levels of competition
- Traditional wooden board designs available upon request
- U.S. patent # 8,337,318

Item Number	Product Description
LTJTOB8	Long / triple jump polyboard take-off board - 8"W
LTJTOB8BL	Long / triple jump polyboard take-off board with blanking lid - 8"W
LTJTOB12	Long / triple jump polyboard take-off board with foul strip - 12"W
LTJTOB12World Athletics	World Athletics Long / triple jump polyboard take-off board with foul strip and blanking lid - 12"W
LTJTOB16	Long / triple jump polyboard take-off board - 16"W
LTJTOB16BL	Long / triple jump polyboard take-off board with blanking lid - 16"W

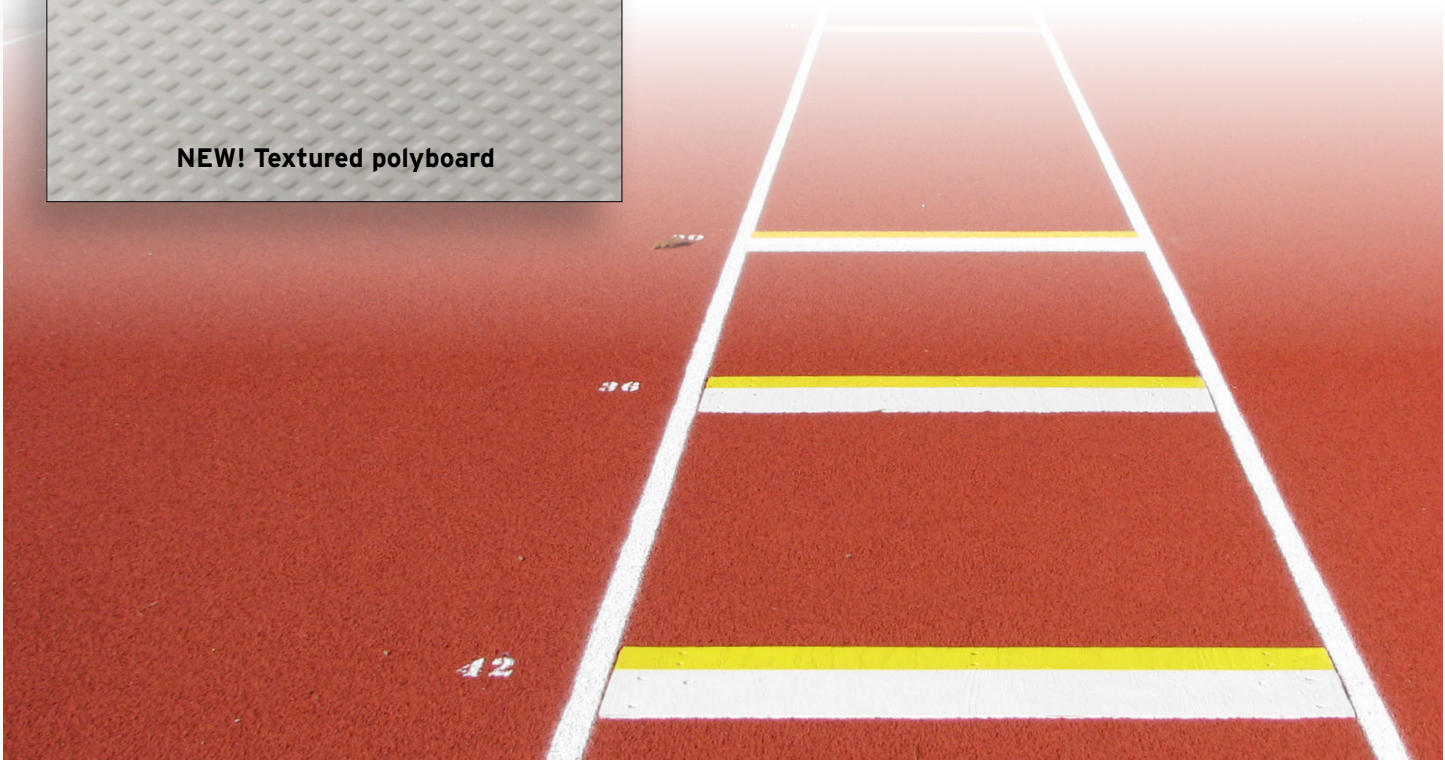
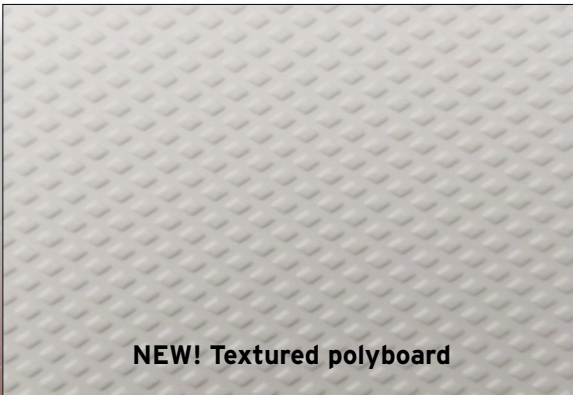



Custom Aluminum Sand Pit Covers

Product Overview

- Custom aluminum cover sets for hand-formed concrete sand pits
- Used to prevent debris contamination and to contain sand within the pit
- Creates a safer offseason condition for your track facility
- Designed to rest on an existing ledge or self-support / "hang"
- Available with a recess for synthetic track surfacing or a flush profile
- Manufactured to the specific dimensions provided by the customer

Item Number	Product Description
SPCVR CSTM	Custom aluminum sand pit covers - ledge install, 1/2" recess
SPCVR CSTMF	Custom aluminum sand pit covers - ledge install, flush profile
SPCVR CSTMH	Custom aluminum sand pit covers - self-support, 1/2" recess



Weighted Mesh & Vinyl Sand Pit Covers

Product Overview

- Constructed with tear/UV resistant mesh and vinyl materials
- Used to prevent debris contamination and to contain sand within the pit
- Integral chain weighted perimeter prevents wind displacement
- Easy handling for high frequency use during track season
- A great seasonal complement to conventional aluminum cover sets
- Choose from a variety of standard color options
- Optional high resolution digitally printed graphics and lettering

Item Number	Product Description
SPCVRM	Weighted single layer mesh cover, 11'-9"W x 25'-6"L
SPCVRMDG	Weighted single layer mesh cover with digital graphics, 11'-9"W x 25'-6"L
SPCVRML	Weighted single layer mesh cover, 11'-9"W x 31'-6"L
SPCVRMLDG	Weighted single layer mesh cover with digital graphics, 11'-9"W x 31'-6"L
SPCVRMCSTM	Custom size weighted single layer mesh cover
SPCVRMCSTMDG	Custom size weighted single layer mesh cover with digital graphics
SPCVRMD	Weighted double layer mesh cover, 11'-9"W x 25'-6"L
SPCVRMDDG	Weighted double layer mesh cover with digital graphics, 11'-9"W x 25'-6"L
SPCVRMDL	Weighted double layer mesh cover, 11'-9"W x 31'-6"L
SPCVRMDLDG	Weighted double layer mesh cover with digital graphics, 11'-9"W x 31'-6"L
SPCVRMDCSTM	Custom size weighted double layer mesh cover
SPCVRMDCSTMDG	Custom size weighted double layer mesh cover with digital graphics
SPCVRV	Weighted solid vinyl cover, 11'-9"W x 25'-6"L
SPCVRVDG	Weighted solid vinyl cover with digital graphics, 11'-9"W x 25'-6"L
SPCVRVL	Weighted solid vinyl cover, 11'-9"W x 31'-6"L
SPCVRVLDG	Weighted solid vinyl cover with digital graphics, 11'-9"W x 31'-6"L
SPCVRVCSTM	Custom size weighted solid vinyl cover
SPCVRVCSTMDG	Custom size weighted solid vinyl cover with digital graphics

United States Patent #7,641,593, Issued January 5, 2010
 United States Patent #8,186,125, Issued May 29, 2012
 United States Patent #8,745,955, Issued June 10, 2014

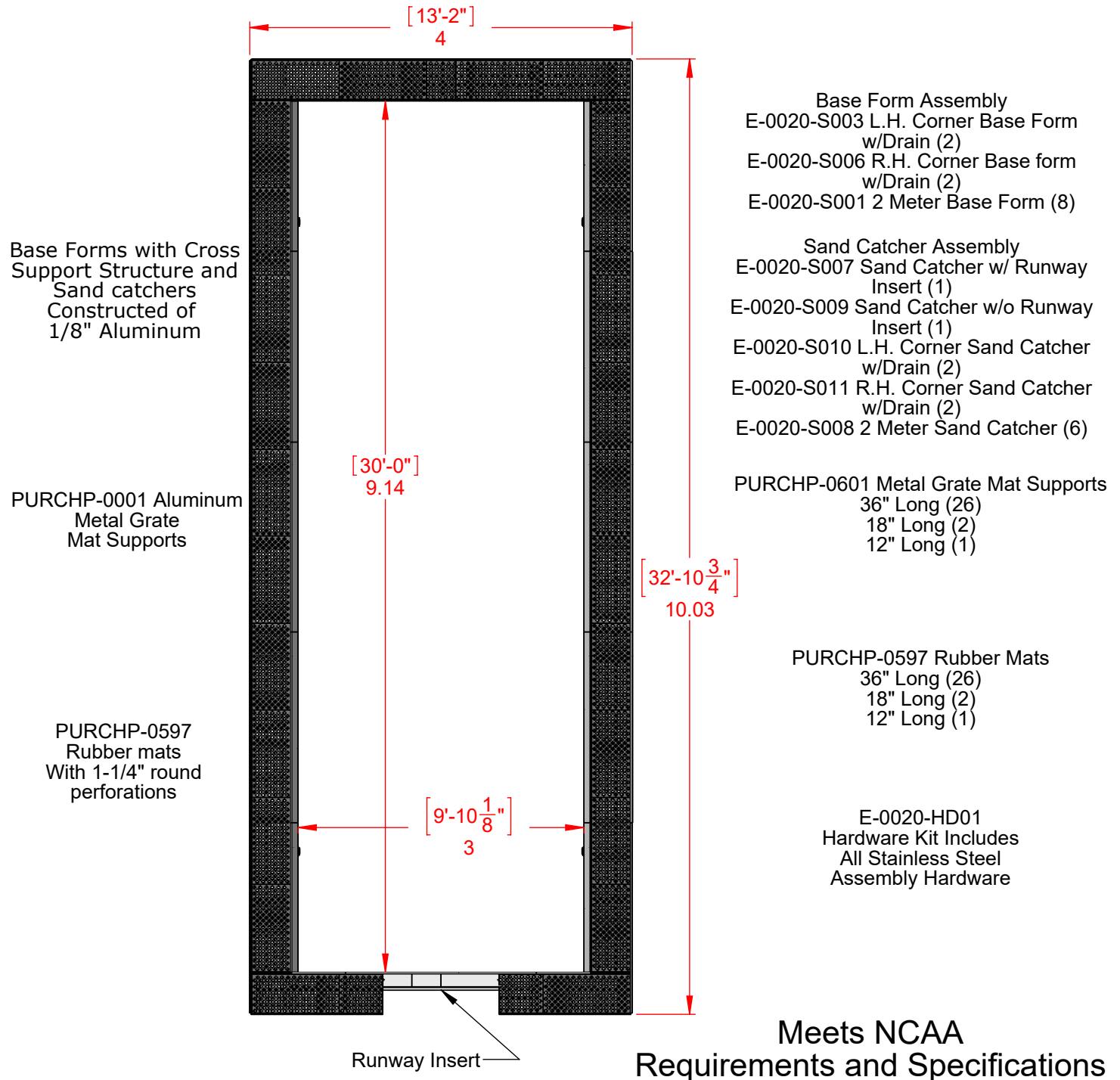

PROPRIETARY AND CONFIDENTIAL

THE INFORMATION CONTAINED IN THIS DRAWING IS THE SOLE PROPERTY OF SPORTSFIELD SPECIALTIES INC. ANY REPRODUCTION IN PART OR AS A WHOLE WITHOUT THE WRITTEN PERMISSION OF SPORTSFIELD SPECIALTIES INC. IS PROHIBITED.

SPSCCOL - JumpForm® College 3M x 9M Sand Pit with Sand Catchers

Not To Scale

Sportsfield Specialties Inc 105847.2-230213

UNITED STATES PATENT #7,641,593, ISSUED JANUARY 5, 2010
 UNITED STATES PATENT #8,186,125, ISSUED MAY 29, 2012
 UNITED STATES PATENT #8,745,955, ISSUED JUNE 10, 2014

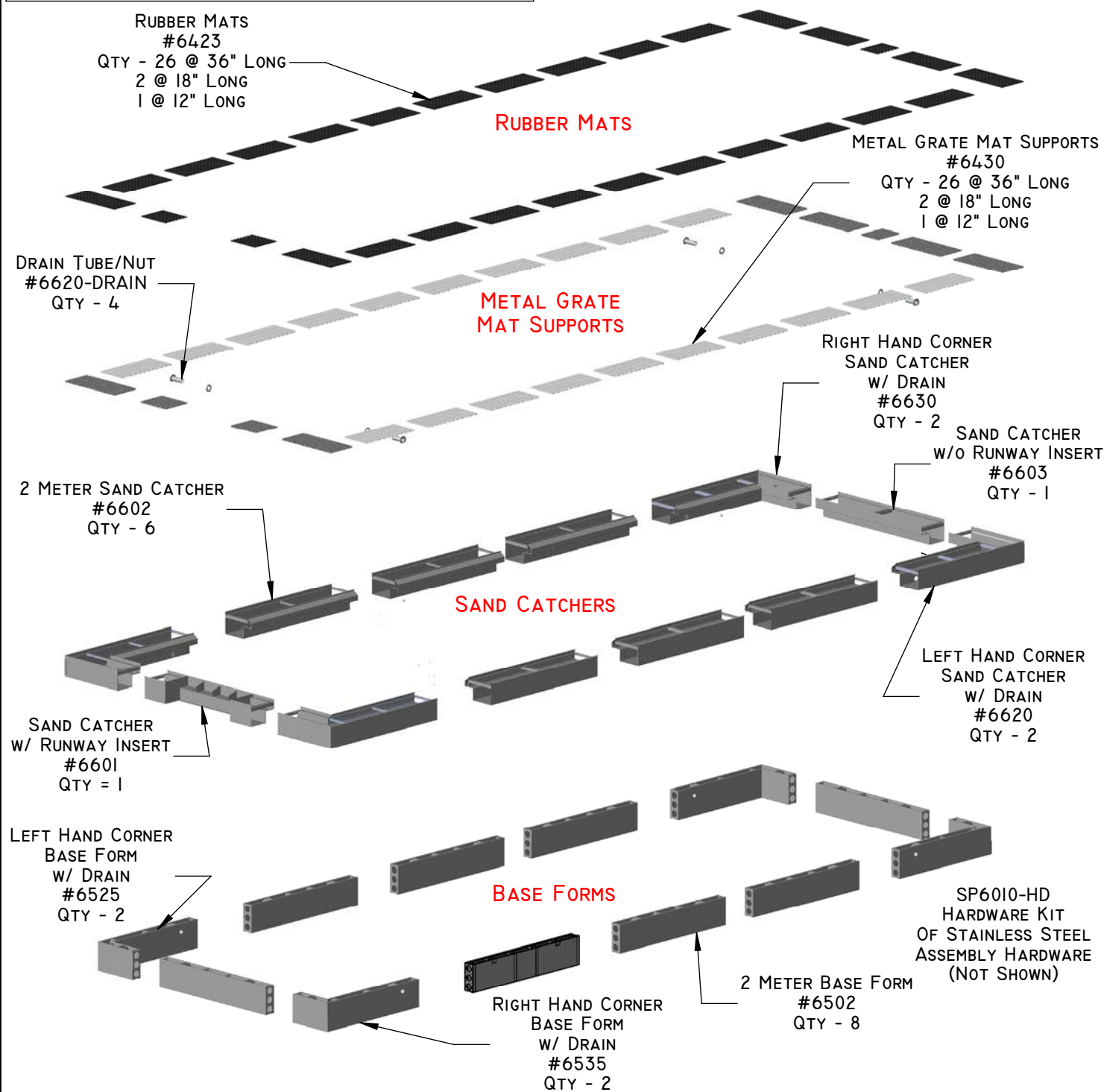

PROPRIETARY AND CONFIDENTIAL
 THE INFORMATION CONTAINED IN THIS DRAWING IS THE SOLE PROPERTY OF SPORTSFIELD SPECIALTIES INC. ANY REPRODUCTION IN PART OR AS A WHOLE WITHOUT THE WRITTEN PERMISSION OF SPORTSFIELD SPECIALTIES INC. IS PROHIBITED.

**SPSCCOL (SP6010) JUMPFORM® EXPLODED VIEW
 COLLEGE 3M X 9M SAND PIT WITH SAND CATCHERS**

NOT TO SCALE

SPORTSFIELD SPECIALTIES INC I2062016

UNITED STATES PATENT #7,641,593
ISSUED JANUARY 5, 2010
UNITED STATES PATENT #8,186,125
ISSUED MAY 29, 2012

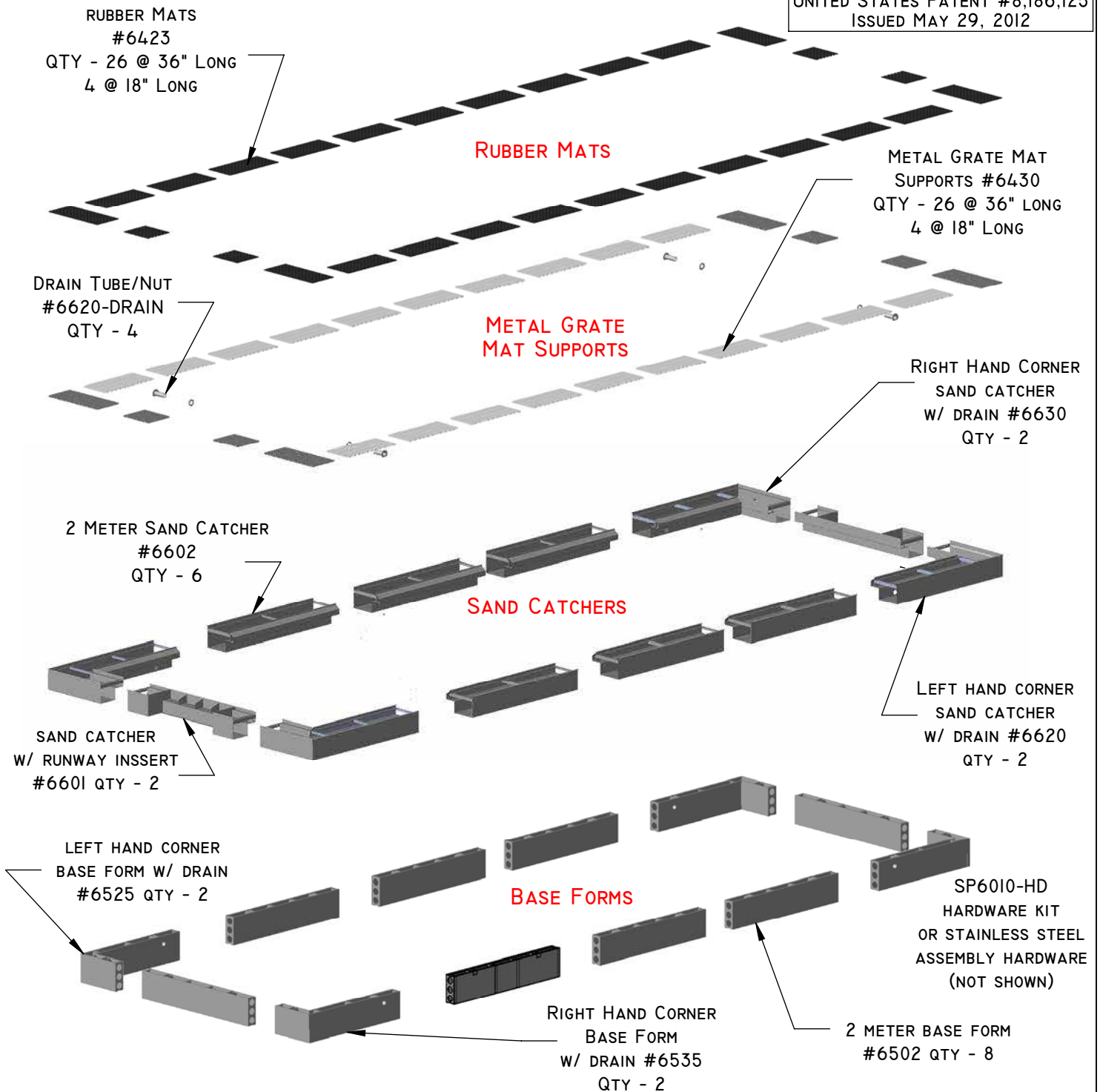

PROPRIETARY AND CONFIDENTIAL
THE INFORMATION CONTAINED IN THIS DRAWING IS THE SOLE PROPERTY OF SPORTSFIELD SPECIALTIES INC. ANY REPRODUCTION IN PART OR AS A WHOLE WITHOUT THE WRITTEN PERMISSION OF SPORTSFIELD SPECIALTIES INC. IS PROHIBITED.

**JUMPFORM® - SPSCCOLDR (SP6010-DUAL) EXPLODED VIEW
COLLEGE 3M x 9M SAND PIT WITH SAND CATCHERS**

NOT TO SCALE

SPORTSFIELD SPECIALTIES INC 12072016

United States Patent #7,641,593, Issued January 5, 2010
 United States Patent #8,186,125, Issued May 29, 2012
 United States Patent #8,745,955, Issued June 10, 2014

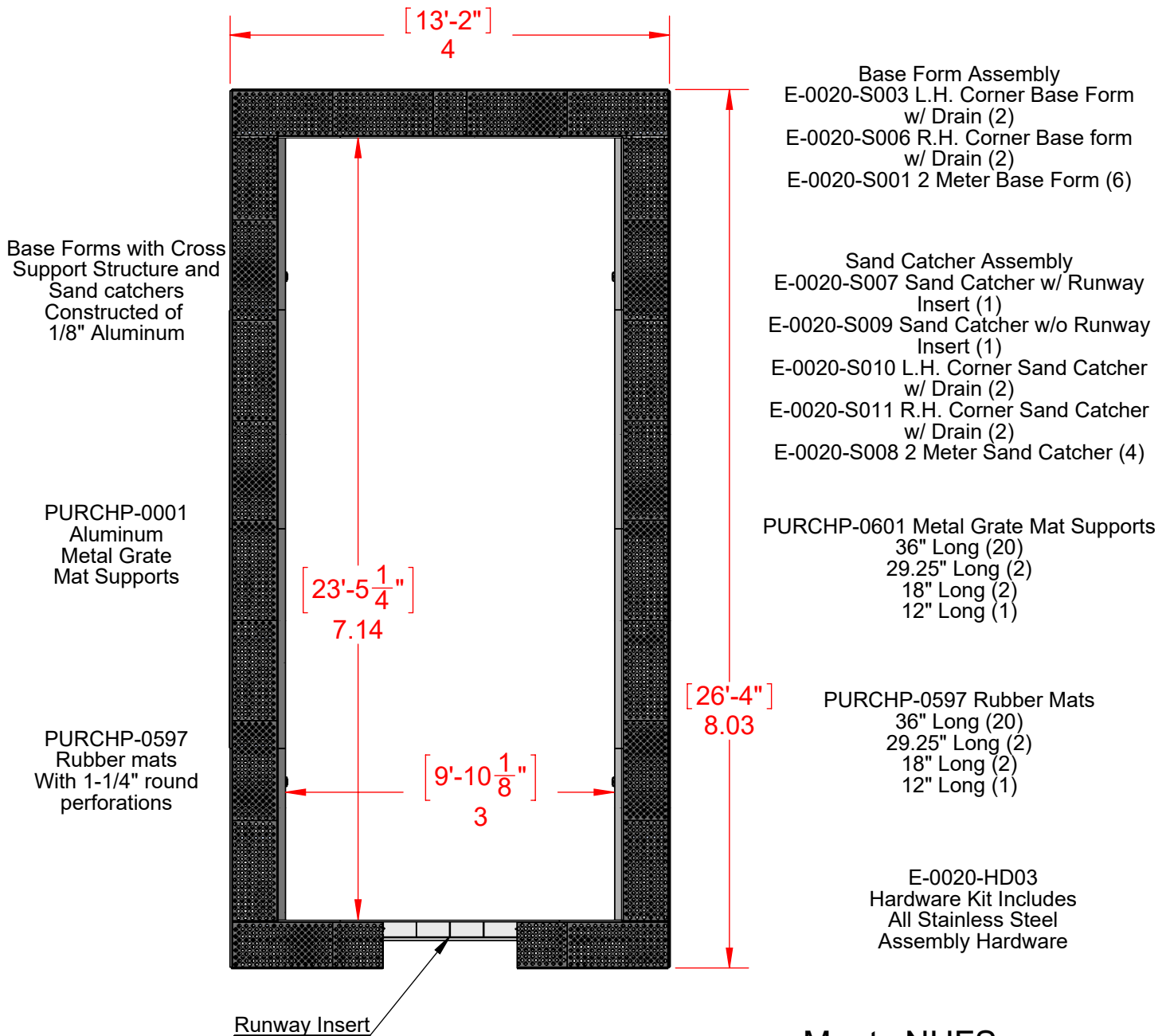

**Meets NHFS
Requirements and Specifications**

PROPRIETARY AND CONFIDENTIAL

THE INFORMATION CONTAINED IN THIS DRAWING IS THE SOLE PROPERTY OF SPORTSFIELD SPECIALTIES INC. ANY REPRODUCTION IN PART OR AS A WHOLE WITHOUT THE WRITTEN PERMISSION OF SPORTSFIELD SPECIALTIES INC. IS PROHIBITED.

**SPSCHS - JumpForm® High School
3M x 7M Sand Pit wth Sand Catchers**

Not To Scale

Sportsfield Specialties Inc 105851.2-230213

UNITED STATES PATENT #7,641,593, ISSUED JANUARY 5, 2010
 UNITED STATES PATENT #8,186,125, ISSUED MAY 29, 2012
 UNITED STATES PATENT #8,745,955, ISSUED JUNE 10, 2014

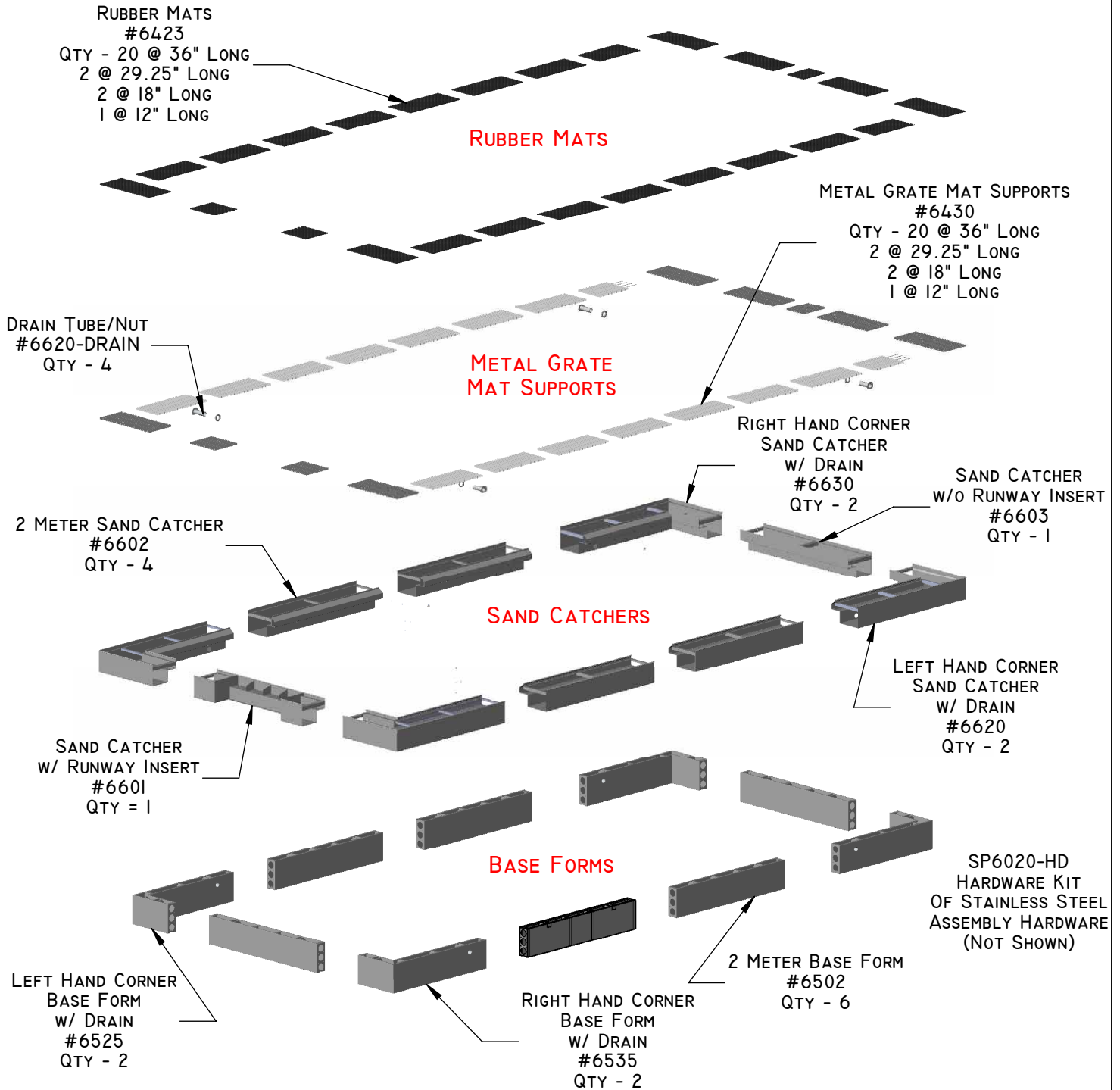

PROPRIETARY AND CONFIDENTIAL
 THE INFORMATION CONTAINED IN THIS DRAWING IS THE SOLE PROPERTY OF SPORTSFIELD SPECIALTIES INC. ANY REPRODUCTION IN PART OR AS A WHOLE WITHOUT THE WRITTEN PERMISSION OF SPORTSFIELD SPECIALTIES INC. IS PROHIBITED.

**SPSCHS (SP6020) JUMPFORM® EXPLODED VIEW
 HIGH SCHOOL 3M x 7M SAND PIT WITH SAND CATCHERS**

NOT TO SCALE

SPORTSFIELD SPECIALTIES INC 12072016

UNITED STATES PATENT #7,641,593
ISSUED JANUARY 5, 2010
UNITED STATES PATENT #8,186,125
ISSUED MAY 29, 2012

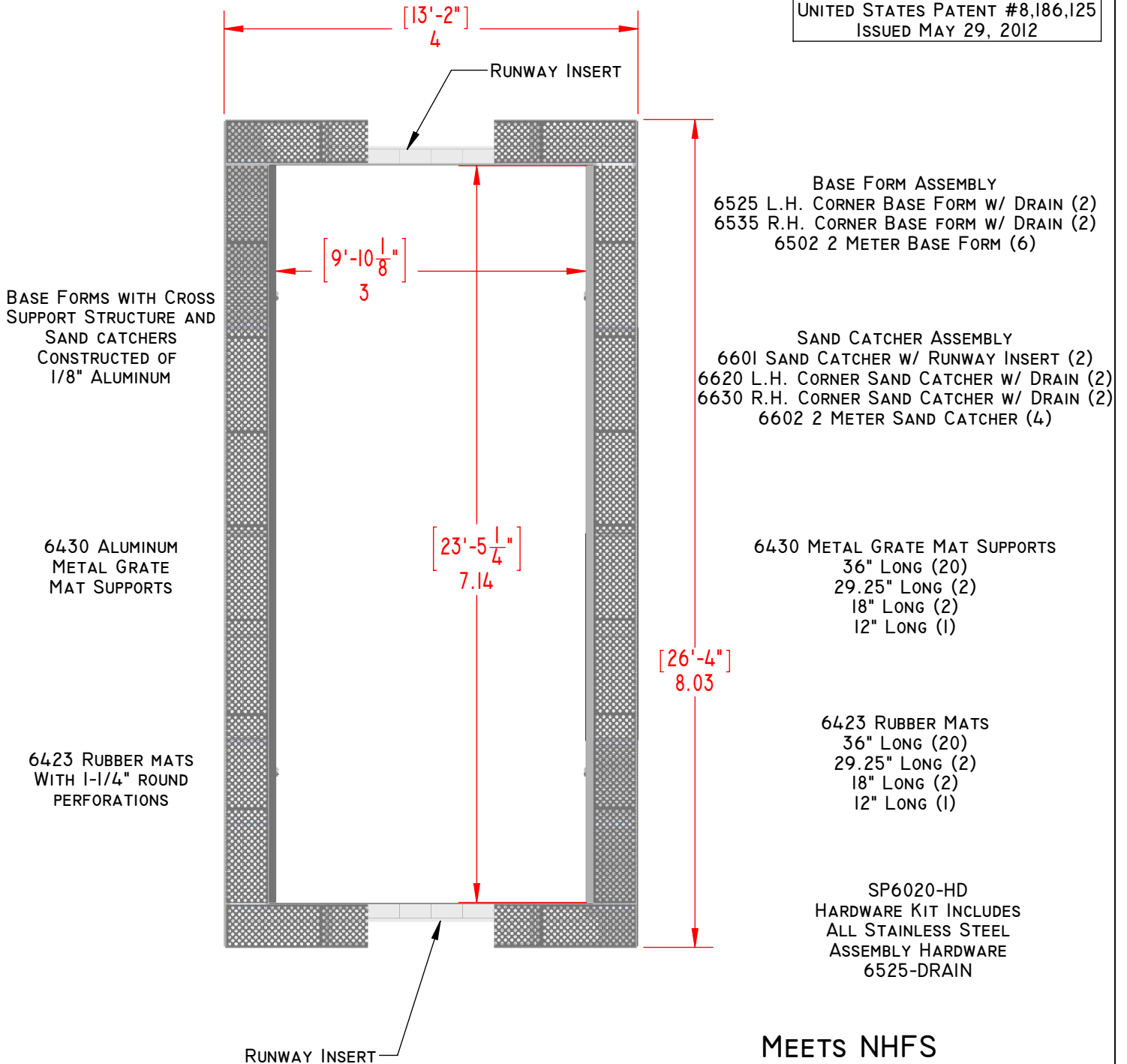

PROPRIETARY AND CONFIDENTIAL
THE INFORMATION CONTAINED IN THIS DRAWING IS THE SOLE PROPERTY OF SPORTSFIELD SPECIALTIES INC. ANY REPRODUCTION IN PART OR AS A WHOLE WITHOUT THE WRITTEN PERMISSION OF SPORTSFIELD SPECIALTIES INC. IS PROHIBITED.

**JUMPFORM® - SPSCHSDR (SP6020-DUAL) OVERVIEW
HIGH SCHOOL 3M x 7M SAND PIT WITH SAND CATCHERS**

NOT TO SCALE

SPORTSFIELD SPECIALTIES INC I2072016

UNITED STATES PATENT #7,641,593
ISSUED JANUARY 5, 2010
UNITED STATES PATENT #8,186,125
ISSUED MAY 29, 2012

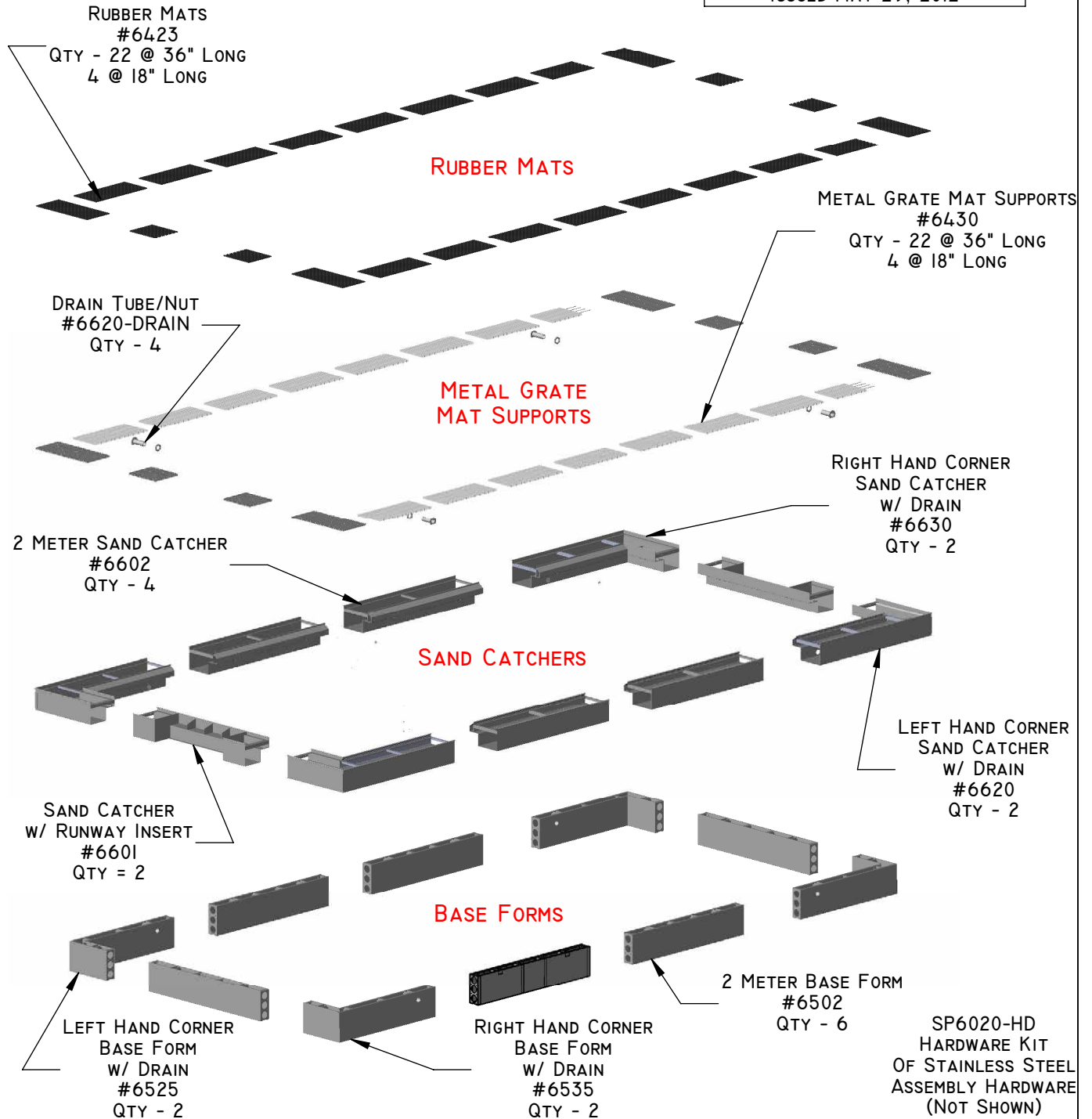

PROPRIETARY AND CONFIDENTIAL

THE INFORMATION CONTAINED IN THIS DRAWING IS THE SOLE PROPERTY OF SPORTSFIELD SPECIALTIES INC. ANY REPRODUCTION IN PART OR AS A WHOLE WITHOUT THE WRITTEN PERMISSION OF SPORTSFIELD SPECIALTIES INC. IS PROHIBITED.

**JUMPFORM® - SPSCHSDR (SP6020-DUAL) EXPLODED VIEW
HIGH SCHOOL 3M x 7M SAND PIT WITH SAND CATCHERS**

NOT TO SCALE

SPORTSFIELD SPECIALTIES INC 12072016

United States Patent #7,641,593, Issued January 5, 2010
 United States Patent #8,186,125, Issued May 29, 2012
 United States Patent #8,745,955, Issued June 10, 2014

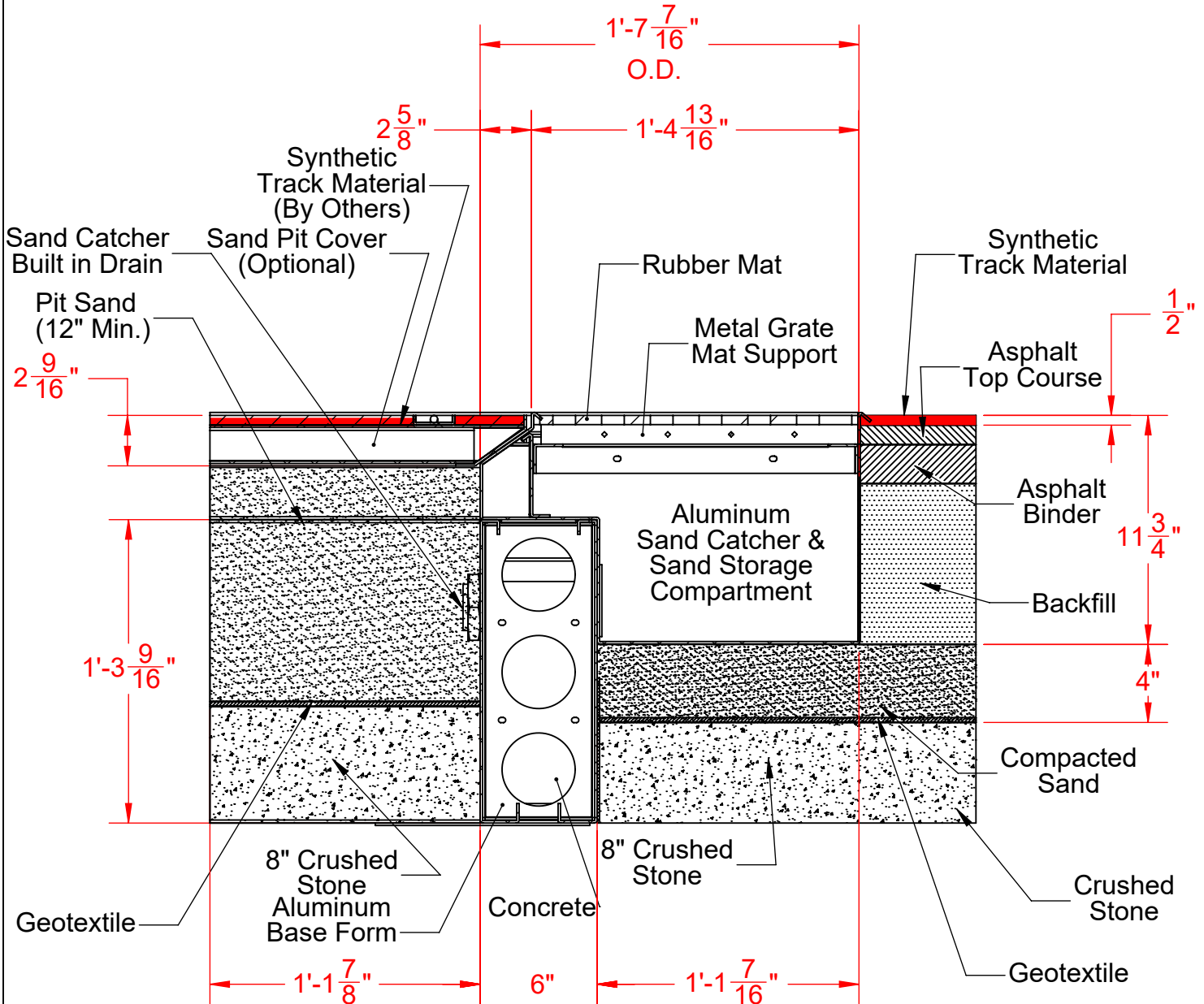

Cross Section May Vary Slightly Due to Local Soil Conditions

PROPRIETARY AND CONFIDENTIAL
 THE INFORMATION CONTAINED IN THIS DRAWING IS THE SOLE PROPERTY OF SPORTSFIELD SPECIALTIES INC. ANY REPRODUCTION IN PART OR AS A WHOLE WITHOUT THE WRITTEN PERMISSION OF SPORTSFIELD SPECIALTIES INC. IS PROHIBITED.

JumpForm® - Sand Pit with Sand Catchers Synthetic Track Material Cross Section

Not To Scale

Sportsfield Specialties Inc 105855.1-221222

UNITED STATES PATENT #7,641,593, ISSUED JANUARY 5, 2010
 UNITED STATES PATENT #8,186,125, ISSUED MAY 29, 2012
 UNITED STATES PATENT #8,745,955, ISSUED JUNE 10, 2014

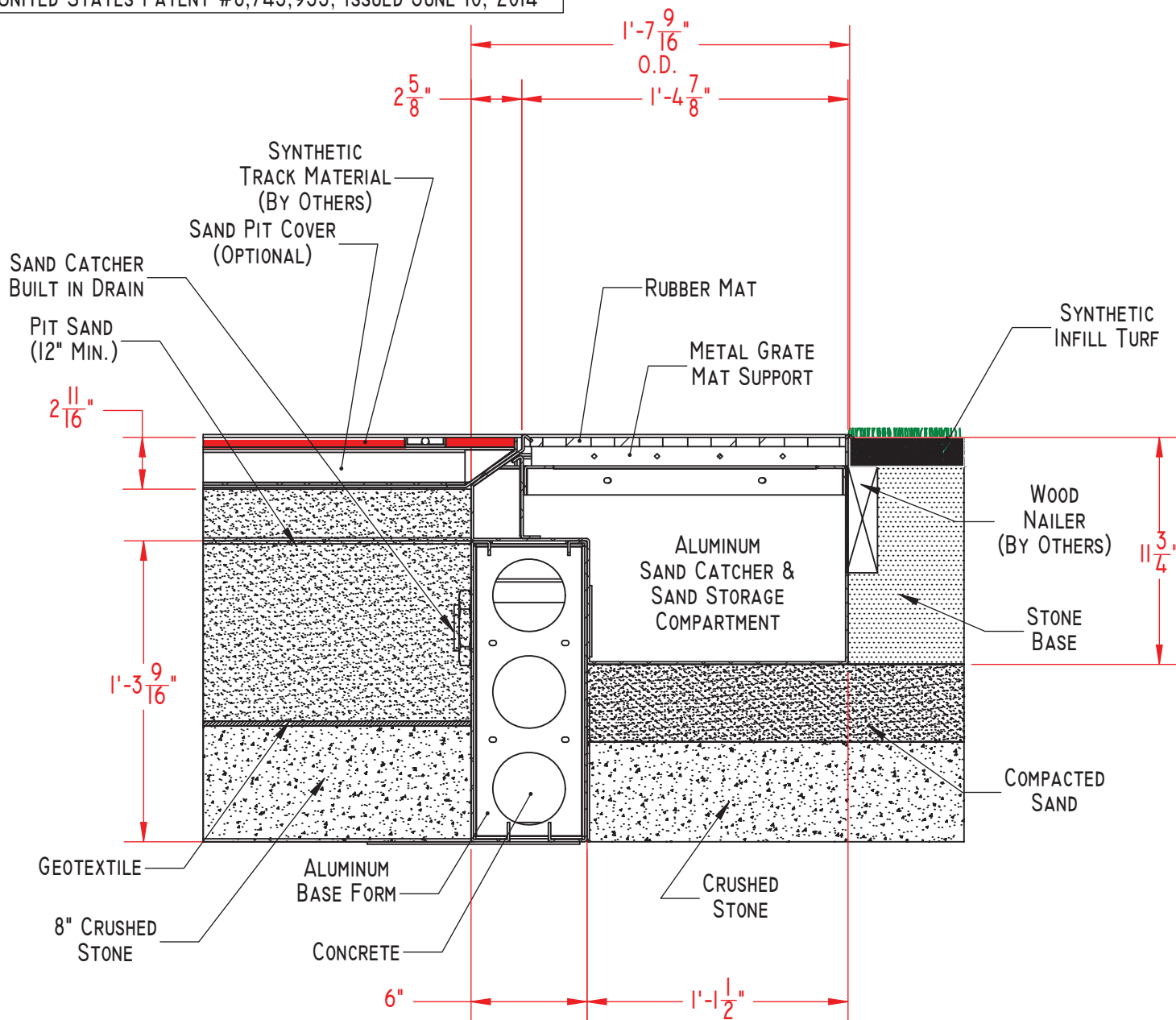

CROSS SECTION MAY VARY
 SLIGHTLY DUE TO LOCAL
 SOIL CONDITIONS

PROPRIETARY AND CONFIDENTIAL

THE INFORMATION CONTAINED IN THIS DRAWING IS THE SOLE PROPERTY OF SPORTSFIELD SPECIALTIES INC. ANY REPRODUCTION IN PART OR AS A WHOLE WITHOUT THE WRITTEN PERMISSION OF SPORTSFIELD SPECIALTIES INC. IS PROHIBITED.

**JUMPFORM® - SAND PIT WITH SAND CATCHERS
 SYNTHETIC INFILL TURF CROSS SECTION**

NOT TO SCALE

SPORTSFIELD SPECIALTIES INC 11012014

United States Patent #7,641,593, Issued January 5, 2010
 United States Patent #8,186,125, Issued May 29, 2012
 United States Patent #8,745,955, Issued June 10, 2014

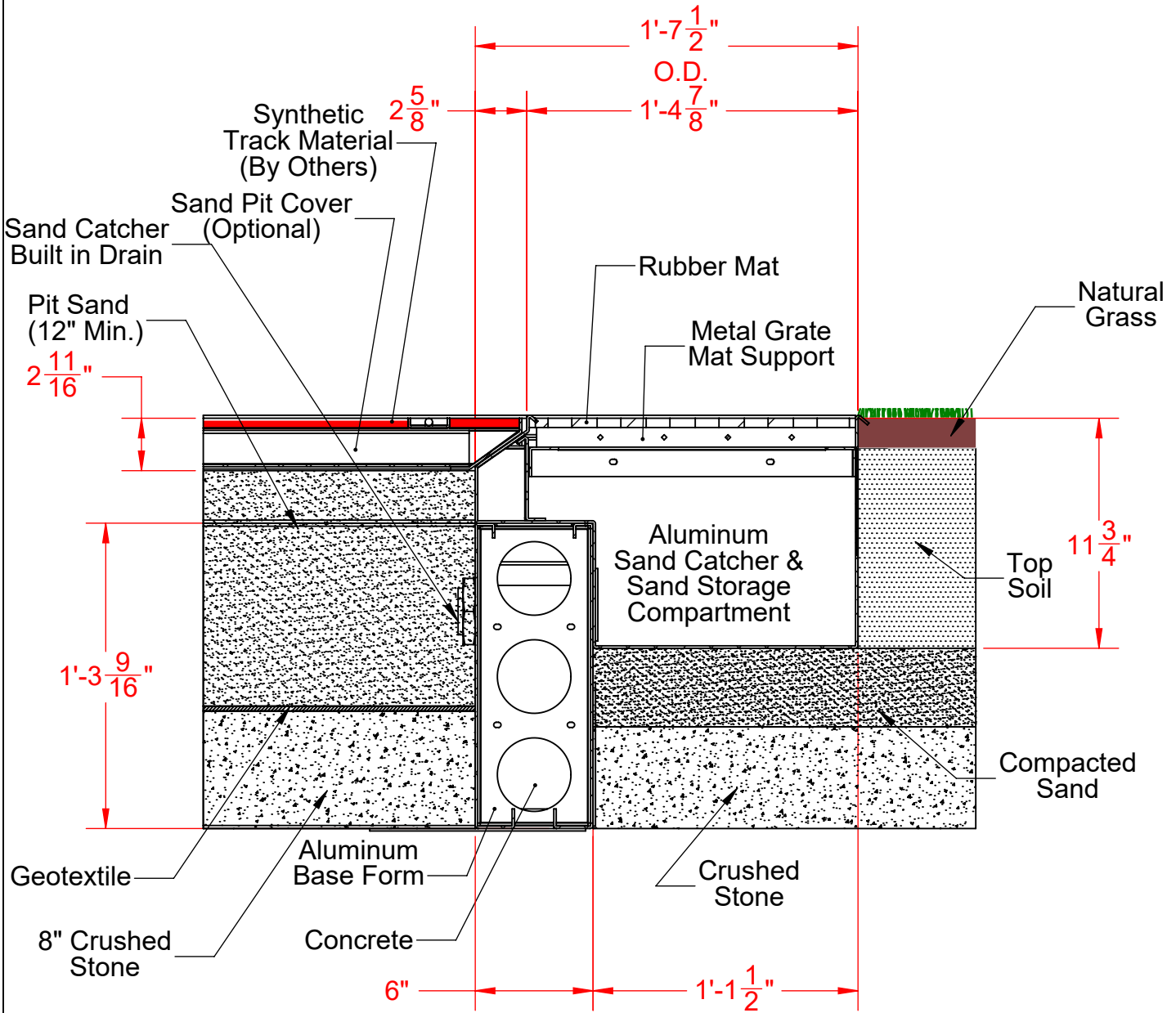

Cross Section May Vary Slightly Due to Local Soil Conditions

PROPRIETARY AND CONFIDENTIAL

THE INFORMATION CONTAINED IN THIS DRAWING IS THE SOLE PROPERTY OF SPORTSFIELD SPECIALTIES INC. ANY REPRODUCTION IN PART OR AS A WHOLE WITHOUT THE WRITTEN PERMISSION OF SPORTSFIELD SPECIALTIES INC. IS PROHIBITED.

JumpForm® - Sand Pit with Sand Catchers Natural Grass Cross Section

Not To Scale

Sportsfield Specialties Inc 105858.1-221222

UNITED STATES PATENT #7,641,593, ISSUED JANUARY 5, 2010
UNITED STATES PATENT #8,745,955, ISSUED JUNE 10, 2014

BASE FORMS WITH CROSS
SUPPORT STRUCTURE AND
COVER LEDGES
CONSTRUCTED OF
1/8" ALUMINUM

SP6012-HD
HARDWARE KIT INCLUDES
ALL STAINLESS STEEL
ASSEMBLY HARDWARE

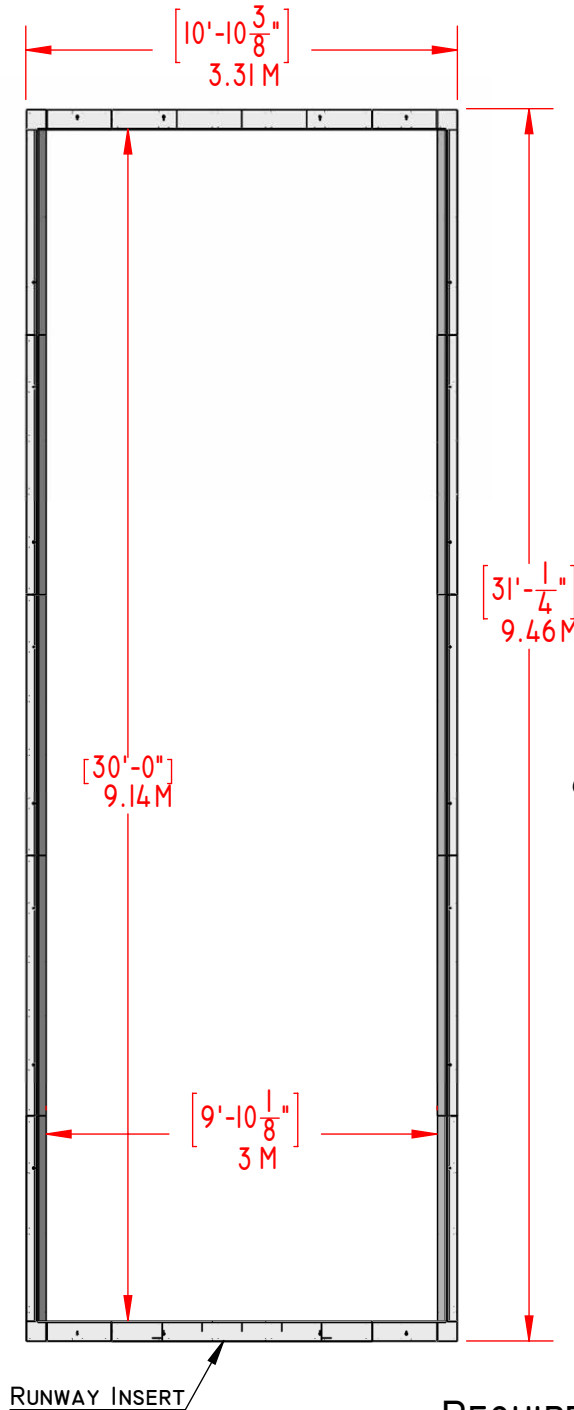

BASE FORM ASSEMBLY
6520 L.H. CORNER BASE FORM (2)
6530 R.H. CORNER BASE FORM (2)
6502 2 METER BASE FORM (8)

COVER LEDGE ASSEMBLY
6701 COVER LEDGE W/ RUNWAY INSERT (1)
6703 COVER LEDGE W/O RUNWAY INSERT (1)
6720 L.H. CORNER COVER LEDGE (2)
6730 R.H. CORNER COVER LEDGE (2)
6702 2 METER COVER LEDGE (6)

**MEETS NCAA
REQUIREMENTS AND SPECIFICATIONS**

PROPRIETARY AND CONFIDENTIAL

THE INFORMATION CONTAINED IN THIS DRAWING IS THE SOLE PROPERTY OF SPORTSFIELD SPECIALTIES INC. ANY REPRODUCTION IN PART OR AS A WHOLE WITHOUT THE WRITTEN PERMISSION OF SPORTSFIELD SPECIALTIES INC. IS PROHIBITED.

**SPCLCOL (SP6012) JUMPFORM®
COLLEGE 3M X 9M SAND PIT WITH COVER LEDGES**

NOT TO SCALE

SPORTSFIELD SPECIALTIES INC 12062012

UNITED STATES PATENT #7,641,593, ISSUED JANUARY 5, 2010
UNITED STATES PATENT #8,745,955, ISSUED JUNE 10, 2014

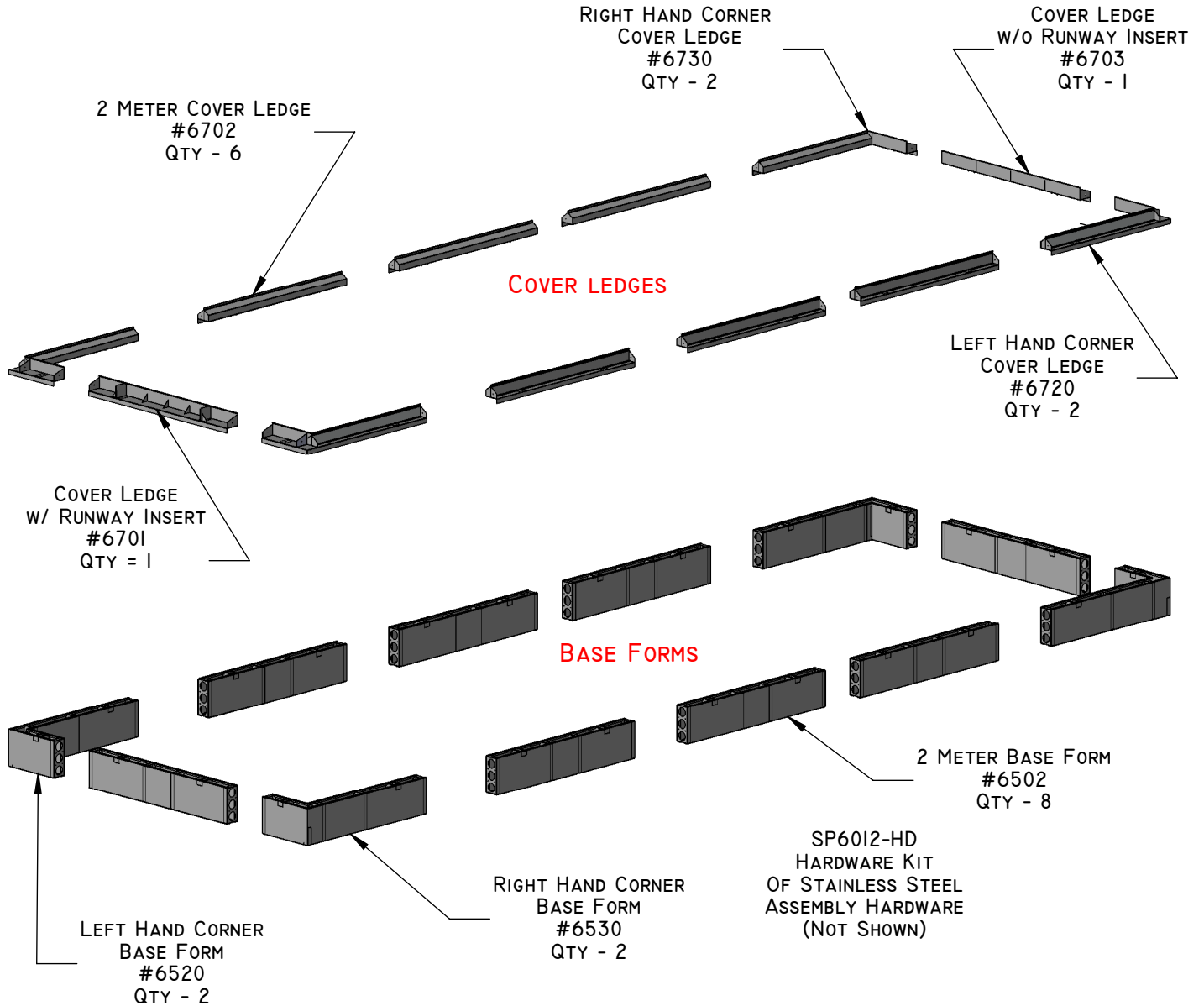

**MEETS NCAA
SPECIFICATIONS AND REQUIREMENTS**

PROPRIETARY AND CONFIDENTIAL
THE INFORMATION CONTAINED IN THIS DRAWING IS THE SOLE PROPERTY OF SPORTSFIELD SPECIALTIES INC. ANY REPRODUCTION IN PART OR AS A WHOLE WITHOUT THE WRITTEN PERMISSION OF SPORTSFIELD SPECIALTIES INC. IS PROHIBITED.

**SPCLCOL (SP6012) JUMPFORM® EXPLODED VIEW
COLLEGE 3M x 9M SAND PIT WITH COVER LEDGES**

NOT TO SCALE

SPORTSFIELD SPECIALTIES INC 12062016

United States Patent #7,641,593, Issued January 5, 2010
 United States Patent #8,745,955, Issued June 10, 2014

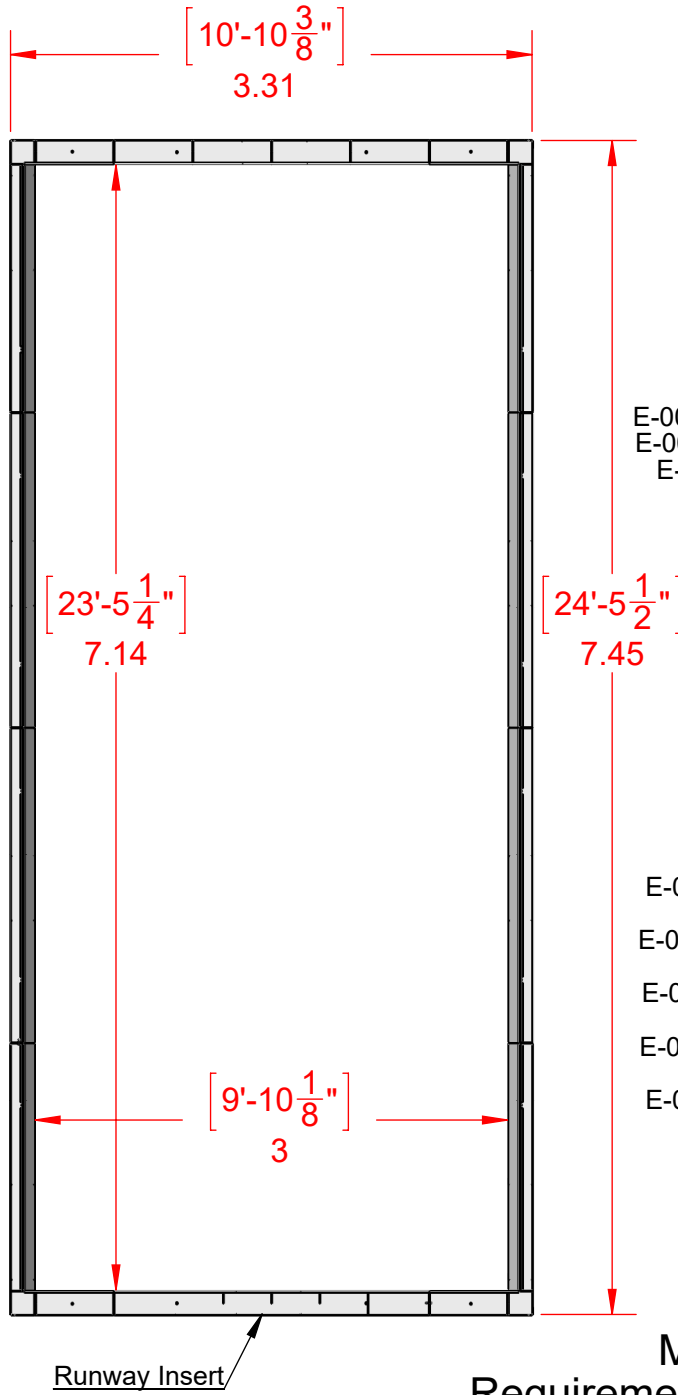

Meets NCAA Requirements and Specifications

PROPRIETARY AND CONFIDENTIAL

THE INFORMATION CONTAINED IN THIS DRAWING IS THE SOLE PROPERTY OF SPORTSFIELD SPECIALTIES INC. ANY REPRODUCTION IN PART OR AS A WHOLE WITHOUT THE WRITTEN PERMISSION OF SPORTSFIELD SPECIALTIES INC. IS PROHIBITED.

**SPCLHS - JumpForm® High School
 3M x 7M Sand Pit with Cover Ledges**

Not To Scale

Sportsfield Specialties Inc 105861.2-230209

United States Patent #7,641,593, Issued January 5, 2010
 United States Patent #8,745,955, Issued June 10, 2014

**Meets NFHS
Specifications and Requirements**

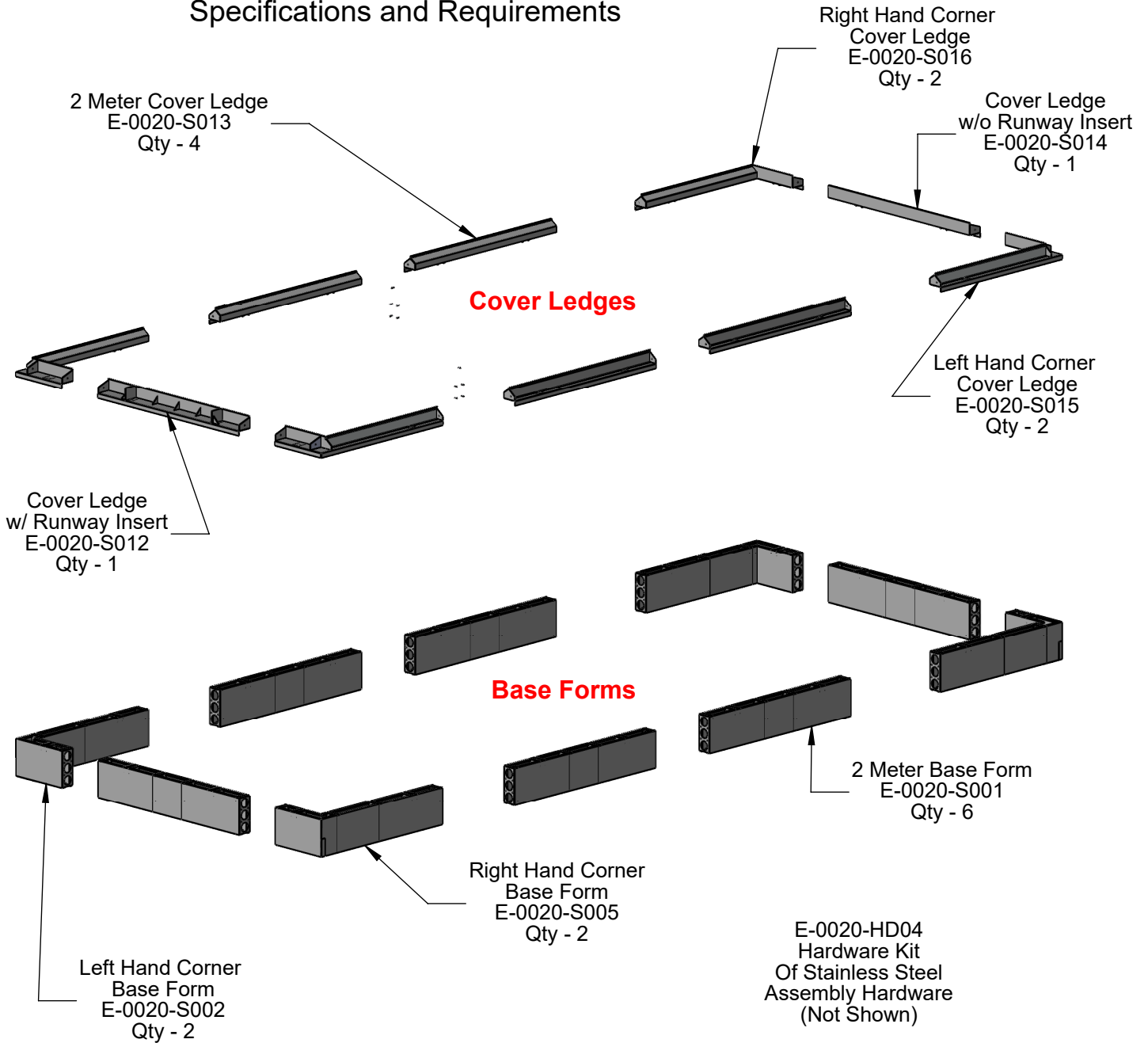

PROPRIETARY AND CONFIDENTIAL

THE INFORMATION CONTAINED IN THIS DRAWING IS THE SOLE PROPERTY OF SPORTSFIELD SPECIALTIES INC. ANY REPRODUCTION IN PART OR AS A WHOLE WITHOUT THE WRITTEN PERMISSION OF SPORTSFIELD SPECIALTIES INC. IS PROHIBITED.

SPCLHS - JumpForm® Exploded View High School 3M x 7M Sand Pit with Cover Ledges

Not To Scale

Sportsfield Specialties Inc 105862.2-230209

United States Patent #7,641,593
 Issued January 5, 2010

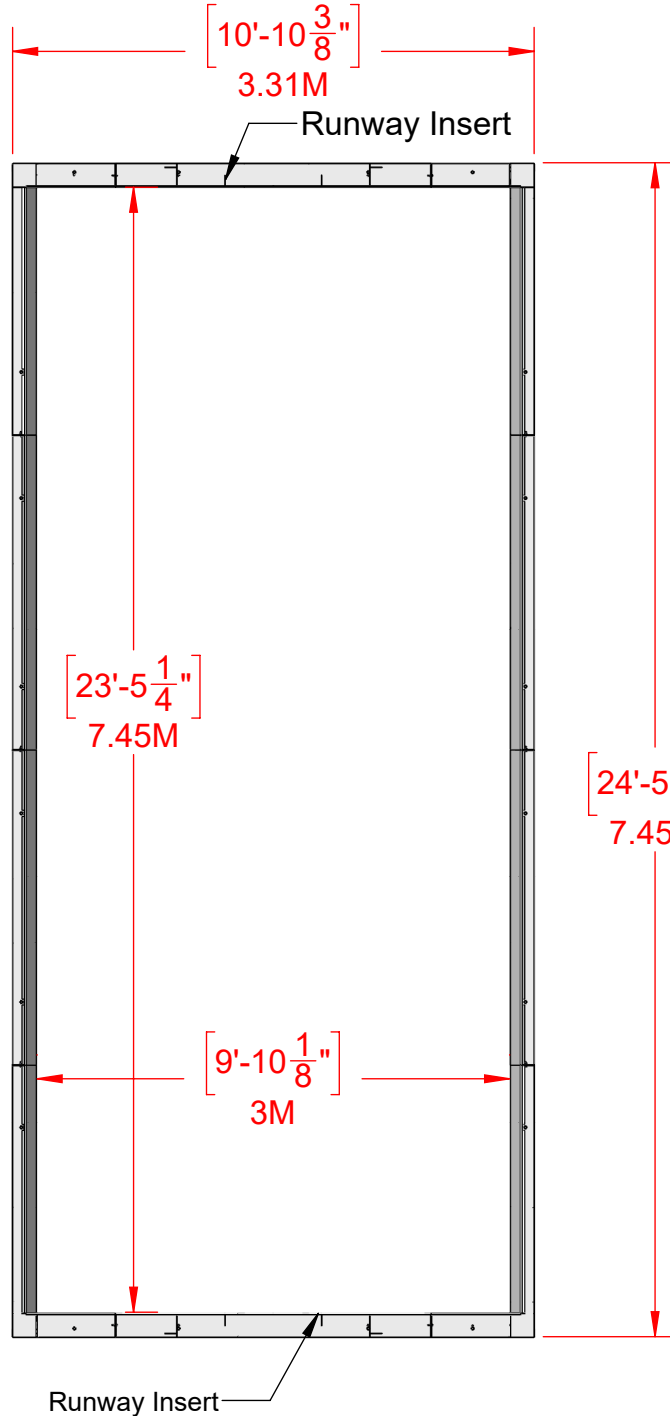

Base Forms with Cross Support Structure and Cover Ledges Constructed of 1/8" Aluminum

Base Form Assembly
 E-0020-S002 L.H. Corner Base Form (2)
 E-0020-S005 R.H. Corner Base form (2)
 E-0020-S001 2 Meter Base Form (6)

E-0020-HD04 Hardware Kit Includes All Stainless Steel Assembly Hardware

Cover Ledge Assembly
 E-0020-S012 Cover Ledge w/ Runway Insert (2)
 E-0020-S015 L.H. Corner Cover Ledge (2)
 E-0020-S016 R.H. Corner Cover Ledge (2)
 E-0020-S013 2 Meter Cover Ledge (4)

Meets NCAA Requirements and Specifications

PROPRIETARY AND CONFIDENTIAL

THE INFORMATION CONTAINED IN THIS DRAWING IS THE SOLE PROPERTY OF SPORTSFIELD SPECIALTIES INC. ANY REPRODUCTION IN PART OR AS A WHOLE WITHOUT THE WRITTEN PERMISSION OF SPORTSFIELD SPECIALTIES INC. IS PROHIBITED.

SPCLHSDR - JumpForm® Overview High School 3M x 7M Sand Pit with Cover Ledges

Not To Scale

Sportsfield Specialties Inc 105863.2-230209

United States Patent #7,641,593
 Issued January 5, 2010
 United States Patent #8,186,125
 Issued May 29, 2012

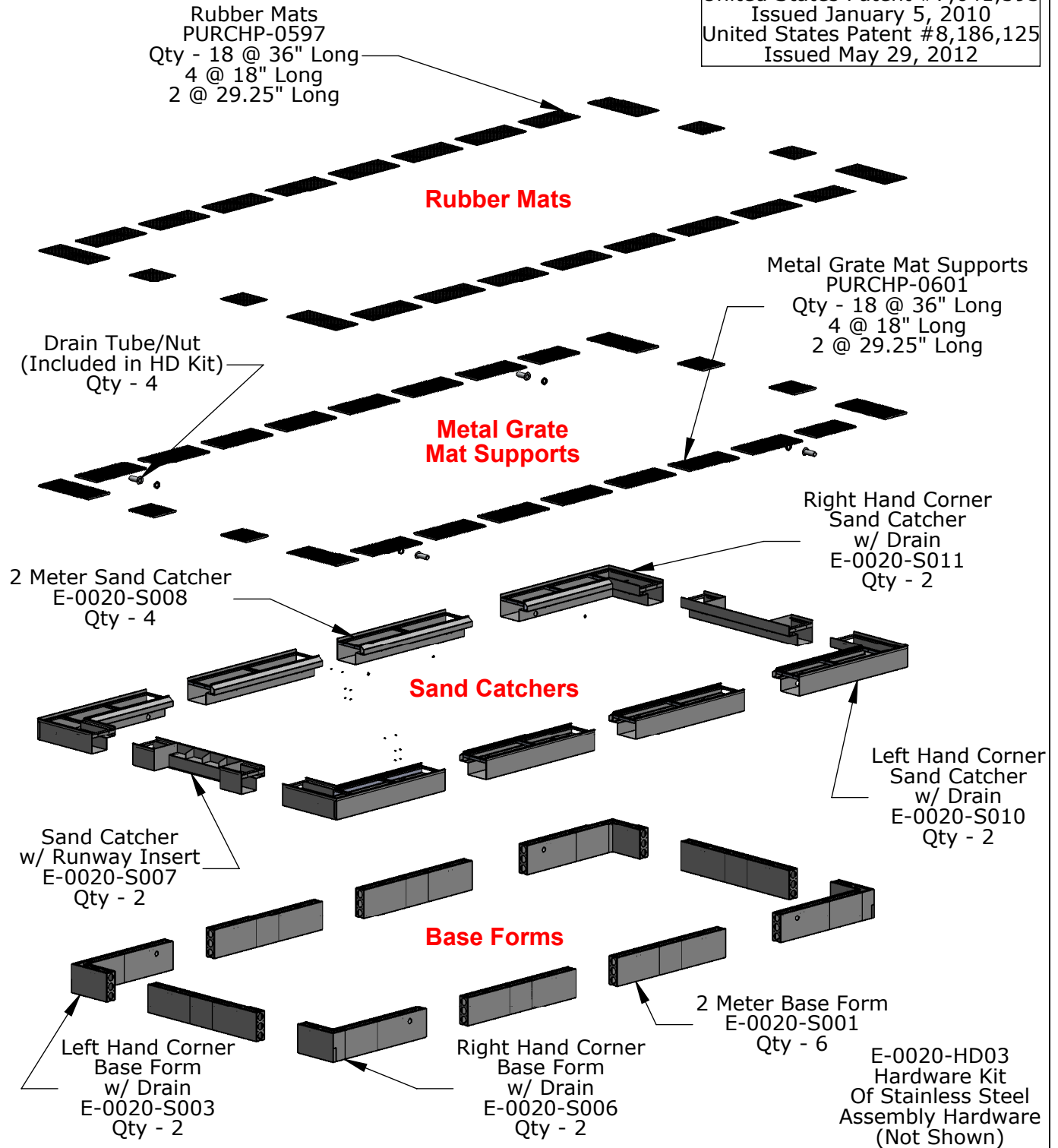

PROPRIETARY AND CONFIDENTIAL

THE INFORMATION CONTAINED IN THIS DRAWING IS THE SOLE PROPERTY OF SPORTSFIELD SPECIALTIES INC. ANY REPRODUCTION IN PART OR AS A WHOLE WITHOUT THE WRITTEN PERMISSION OF SPORTSFIELD SPECIALTIES INC. IS PROHIBITED.

**SPSCHSDR - JumpForm® Exploded View
 High School 3M x 7M Sand Pit with Sand Catchers**

Not To Scale

Sportsfield Specialties Inc 105854.2-230209

United States Patent #7,641,593, Issued January 5, 2010
 United States Patent #8,745,955, Issued June 10, 2014

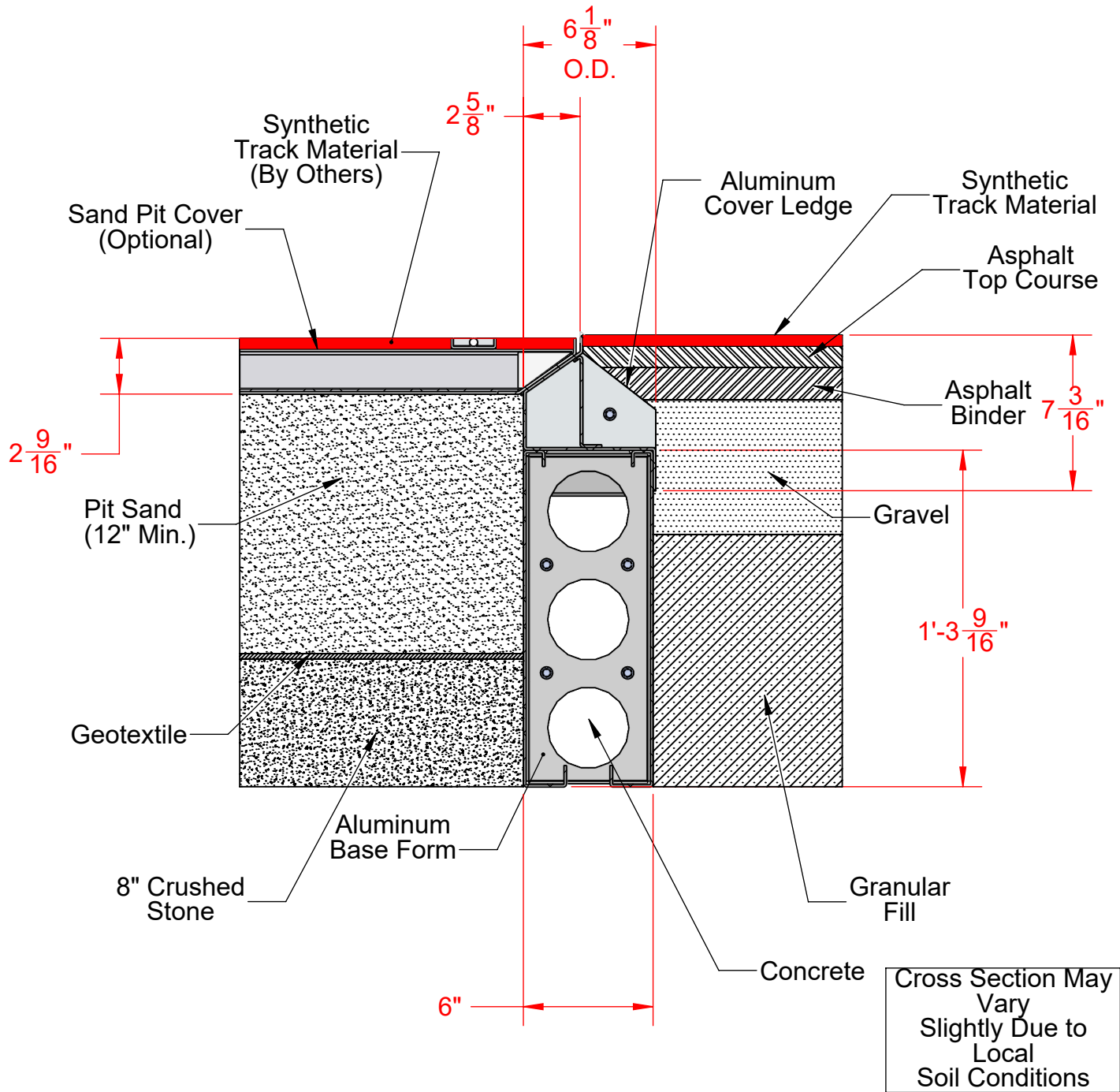

PROPRIETARY AND CONFIDENTIAL
 THE INFORMATION CONTAINED IN THIS DRAWING IS THE SOLE PROPERTY OF SPORTSFIELD SPECIALTIES INC. ANY REPRODUCTION IN PART OR AS A WHOLE WITHOUT THE WRITTEN PERMISSION OF SPORTSFIELD SPECIALTIES INC. IS PROHIBITED.

JumpForm® Sand Pit with Cover Ledges Synthetic Track Material Cross Section

Not To Scale

Sportsfield Specialties Inc 105874.1-22122722

United States Patent #7,641,593, Issued January 5, 2010
 United States Patent #8,745,955, Issued June 10, 2014

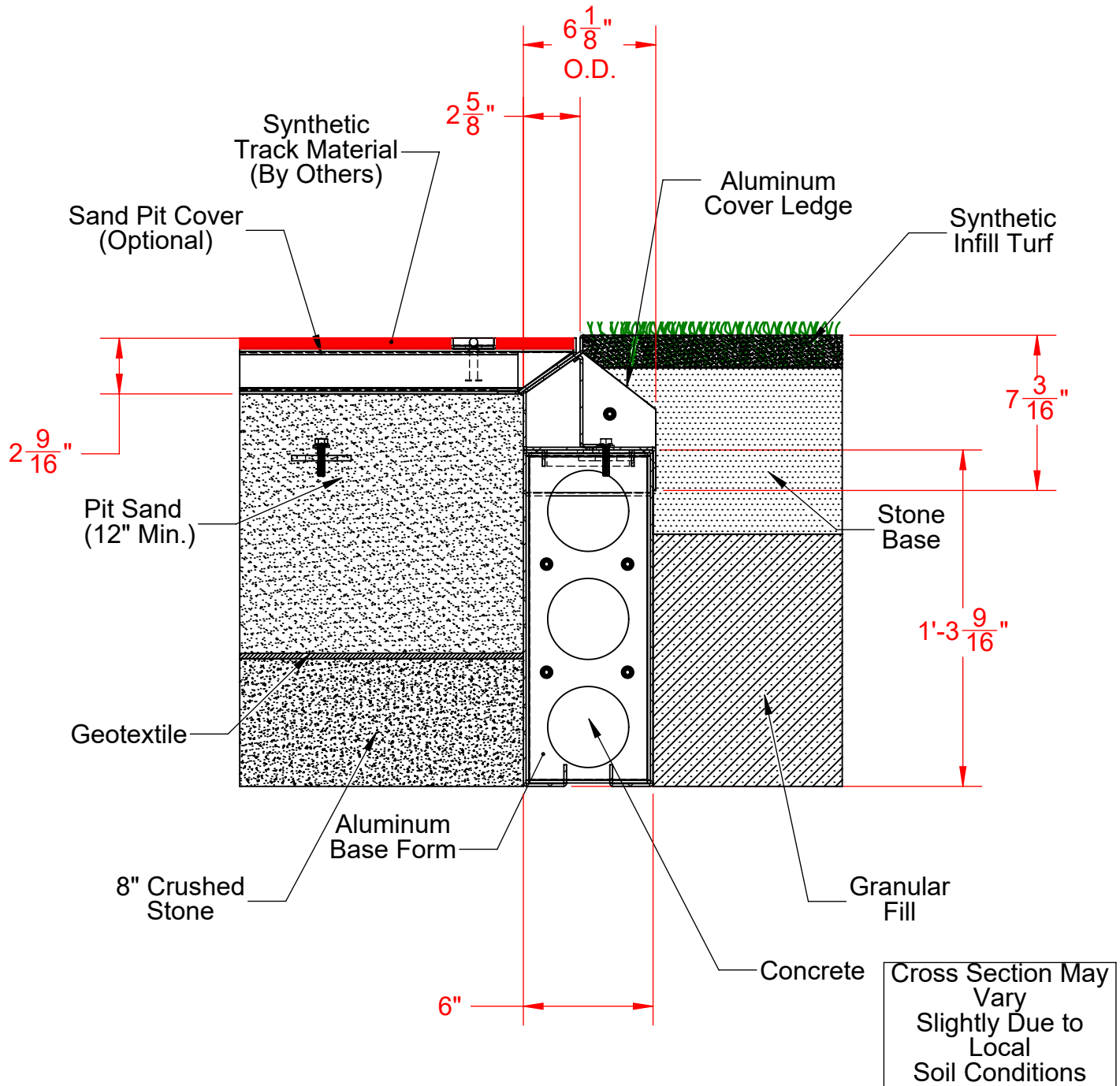

PROPRIETARY AND CONFIDENTIAL

THE INFORMATION CONTAINED IN THIS DRAWING IS THE SOLE PROPERTY OF SPORTSFIELD SPECIALTIES INC. ANY REPRODUCTION IN PART OR AS A WHOLE WITHOUT THE WRITTEN PERMISSION OF SPORTSFIELD SPECIALTIES INC. IS PROHIBITED.

JumpForm® Sand Pit with Cover Ledges Synthetic Infill Turf Cross Section

Not To Scale

Sportsfield Specialties Inc 105875.1-221227

United States Patent #7,641,593, Issued January 5, 2010
 United States Patent #8,745,955, Issued June 10, 2014

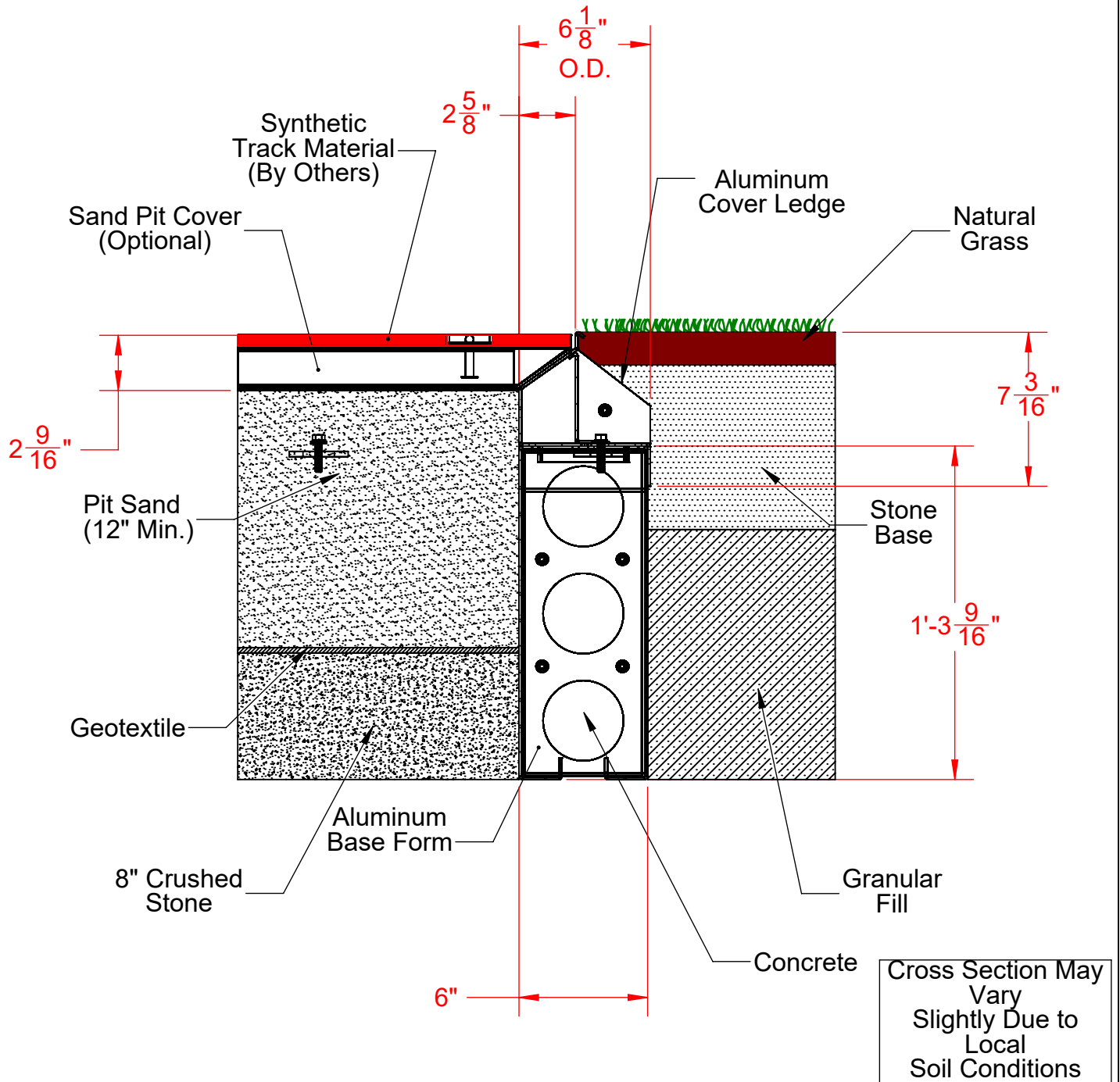

PROPRIETARY AND CONFIDENTIAL

THE INFORMATION CONTAINED IN THIS DRAWING IS THE SOLE PROPERTY OF SPORTSFIELD SPECIALTIES INC. ANY REPRODUCTION IN PART OR AS A WHOLE WITHOUT THE WRITTEN PERMISSION OF SPORTSFIELD SPECIALTIES INC. IS PROHIBITED.

**JumpForm® Sand Pit with Cover Ledges
 Natural Grass Cross Section**

Not To Scale

Sportsfield Specialties Inc 105876.1-221227

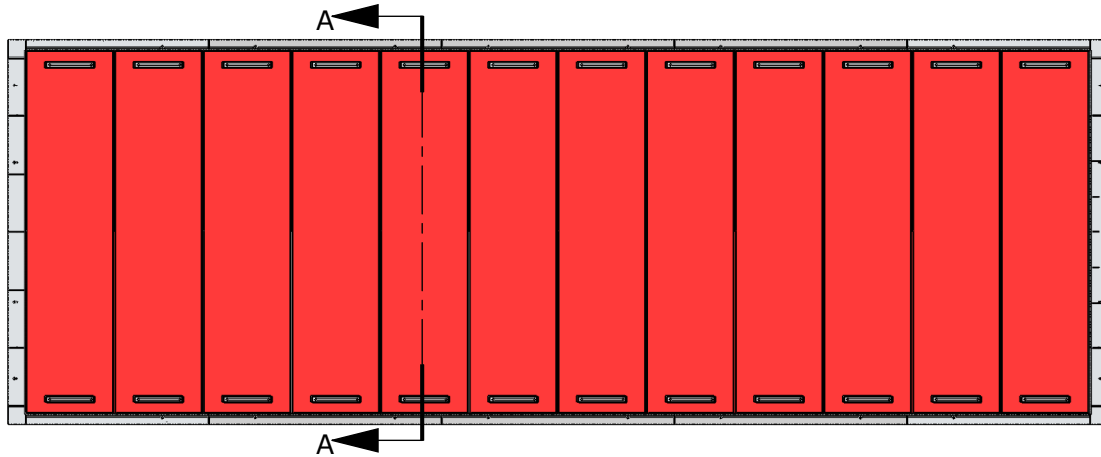

Important: It is highly recommended that the synthetic track installer use a suitable metal primer prior to installing the synthetic track surface to ensure proper adhesion. Failure to do so may cause premature delamination of the synthetic track material.

Recess to Accept Synthetic Track Surface, By Others (See Table for Depth)

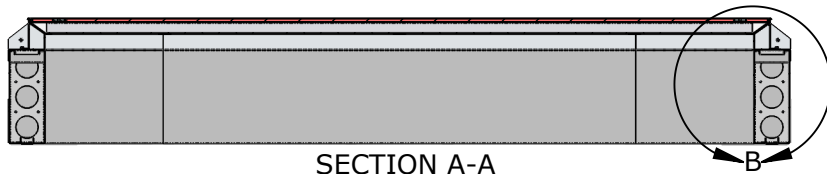

SECTION A-A

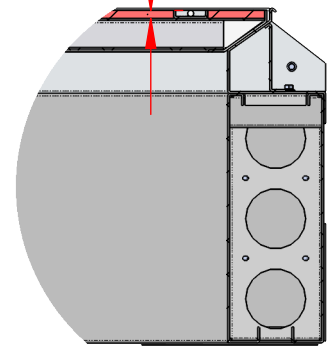

DETAIL B

Standard Cover
Qty: 12
80 lbs per Cover*

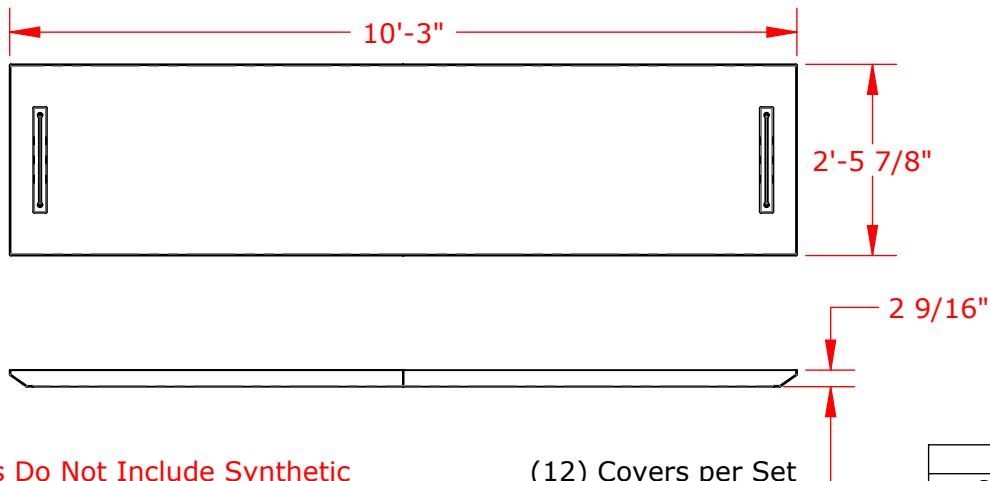

*Weights Do Not Include Synthetic Track Surface

(12) Covers per Set
960 lbs per Set*

Part #	Recess Depth
SPCVRCOL	1/2"
SPCVRCOLQ	1/4"

PROPRIETARY AND CONFIDENTIAL

THE INFORMATION CONTAINED IN THIS DRAWING IS THE SOLE PROPERTY OF SPORTSFIELD SPECIALTIES INC. ANY REPRODUCTION IN PART OR AS A WHOLE WITHOUT THE WRITTEN PERMISSION OF SPORTSFIELD SPECIALTIES INC. IS PROHIBITED.

College Sand Pit Cover Set

Not To Scale

Sportsfield Specialties Inc 07222020

SPCVRCOLM College Sand Pit Cover Set

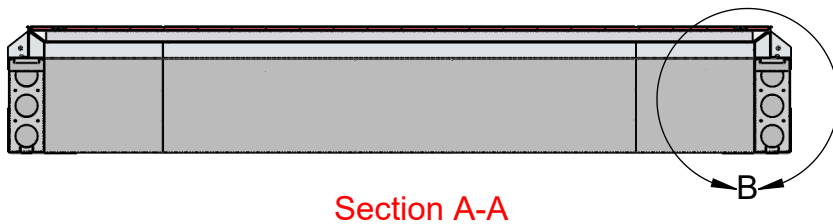
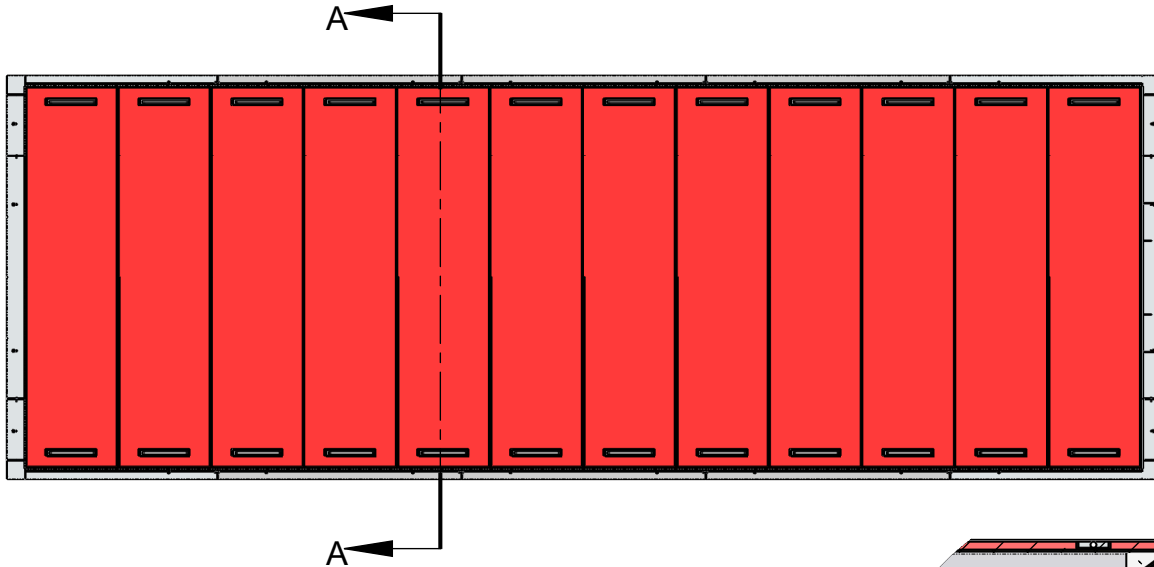

Section A-A

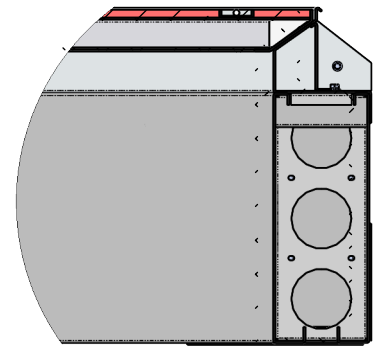

Detail B

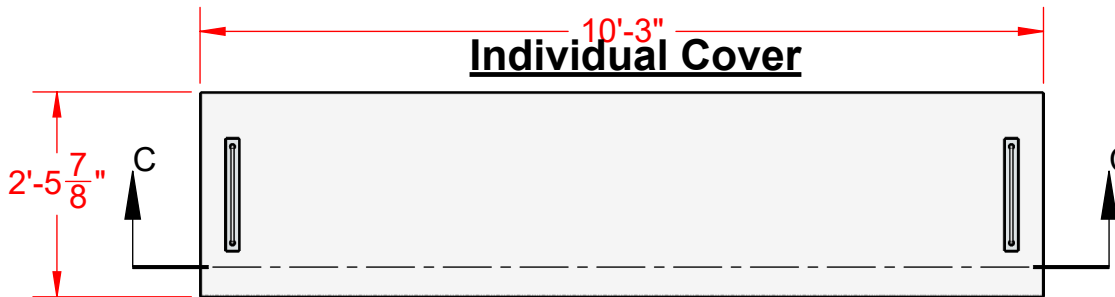

Product Weights

1,788 lbs/Set
 149 lbs Each

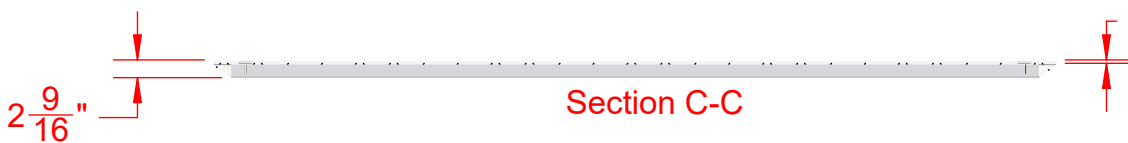

**1/2" Recess to Accept
 Factory Pre-Installed
 Black Rubber Mat
 Material**

PROPRIETARY AND CONFIDENTIAL

THE INFORMATION CONTAINED IN THIS DRAWING IS THE SOLE PROPERTY OF SPORTSFIELD SPECIALTIES INC. ANY REPRODUCTION IN PART OR AS A WHOLE WITHOUT THE WRITTEN PERMISSION OF SPORTSFIELD SPECIALTIES INC. IS PROHIBITED.

**SPCVRCOLM - College Sand Pit Cover Set with
 Factory Pre-Installed Black Rubber Mat Material**

Not To Scale

Sportsfield Specialties Inc 105846.1-221222

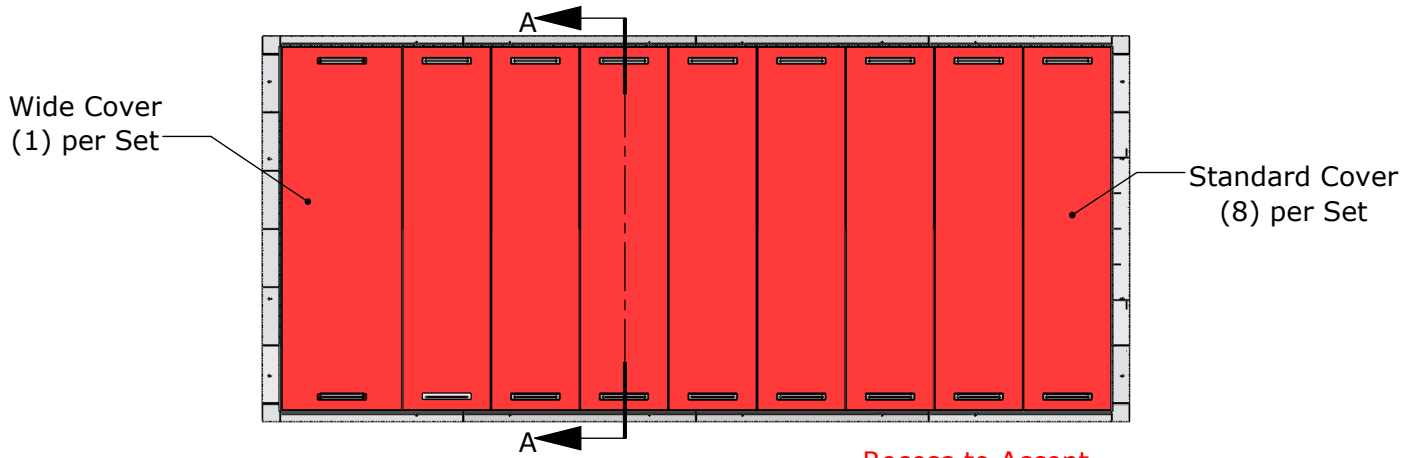

Important: It is highly recommended that the synthetic track installer use a suitable metal primer prior to installing the synthetic track surface to ensure proper adhesion. Failure to do so may cause premature delamination of the synthetic track material.

Recess to Accept Synthetic Track Surface, By Others (See Table for Depth)

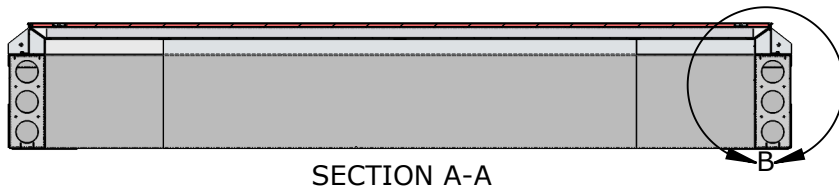
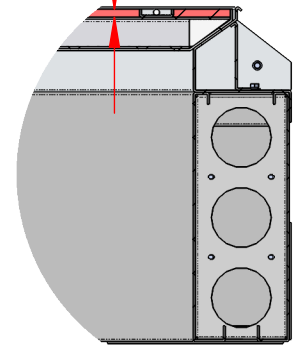

Standard Cover
Qty: 8
80 lbs per Cover*

Wide Cover
Qty: 1
95 lbs per Cover*

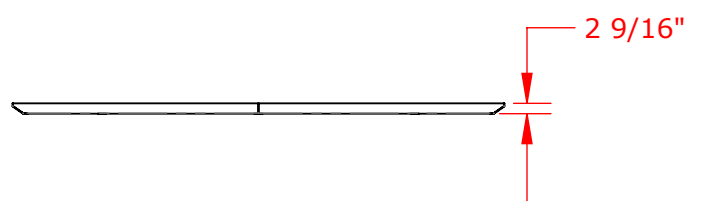
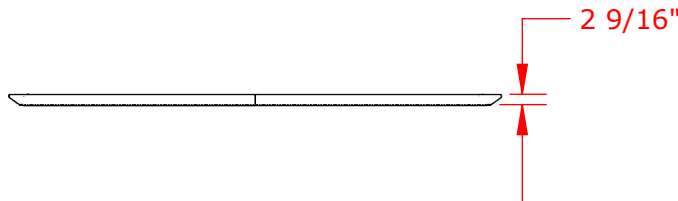
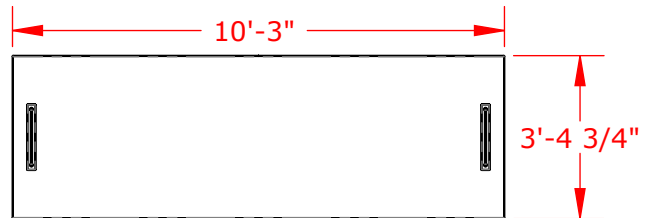
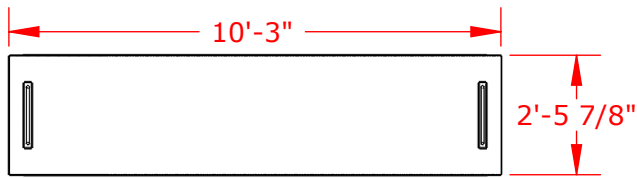

*Weights Do Not Include Synthetic Track Surface

(9) Covers per Set
735 lbs per Set*

Part #	Recess Depth
SPCVRHS	1/2"
SPCVRHSQ	1/4"

PROPRIETARY AND CONFIDENTIAL

THE INFORMATION CONTAINED IN THIS DRAWING IS THE SOLE PROPERTY OF SPORTSFIELD SPECIALTIES INC. ANY REPRODUCTION IN PART OR AS A WHOLE WITHOUT THE WRITTEN PERMISSION OF SPORTSFIELD SPECIALTIES INC. IS PROHIBITED.

High School Sand Pit Cover Set

Not To Scale

Sportsfield Specialties Inc 07222020

SPCVRHSM High School Sand Pit Cover Set

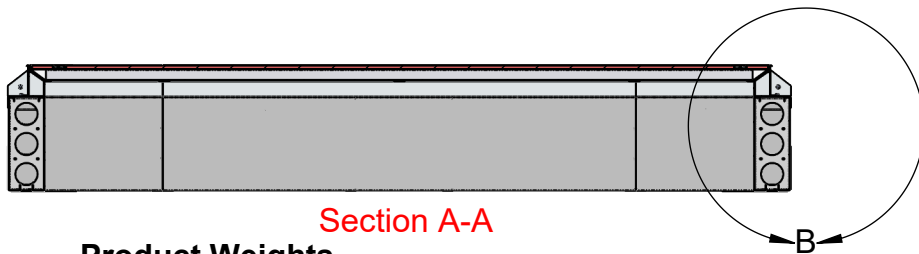
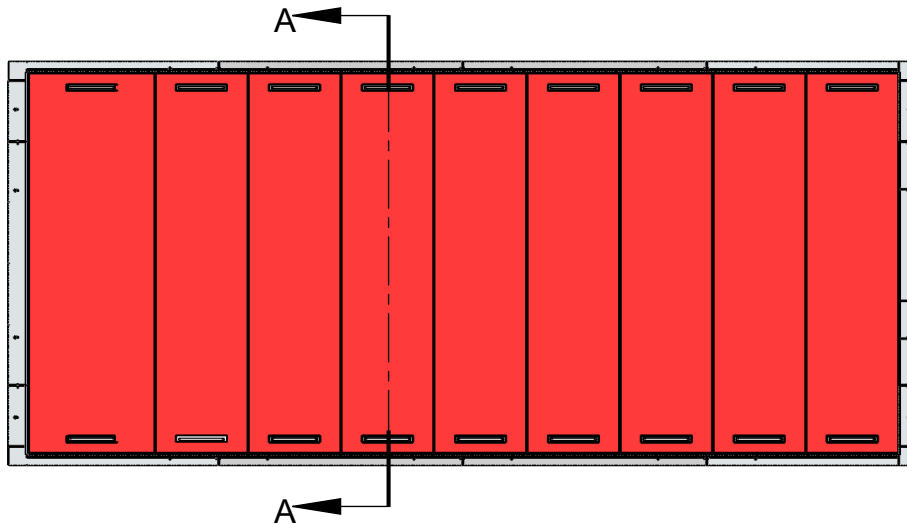

Section A-A

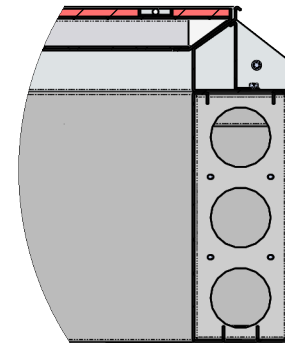

Detail B

Product Weights
 Cover Set - 1,378lbs/Set
 Small Cover - 149 lbs Each
 Large Cover - 186 lbs Each

Small Individual Cover

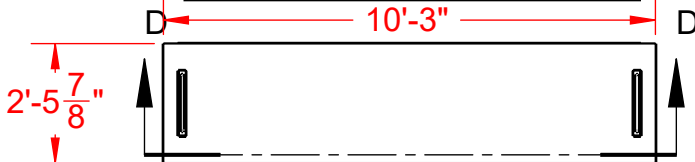

Large Individual Cover

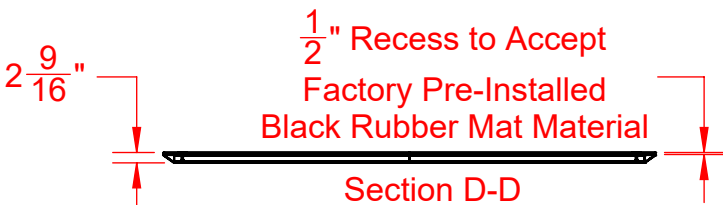
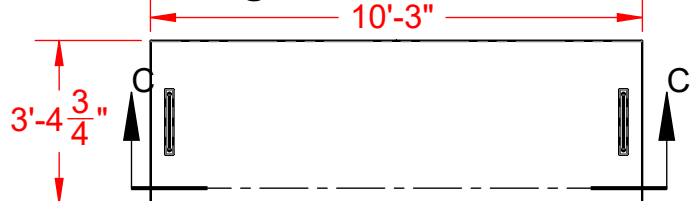

Section D-D

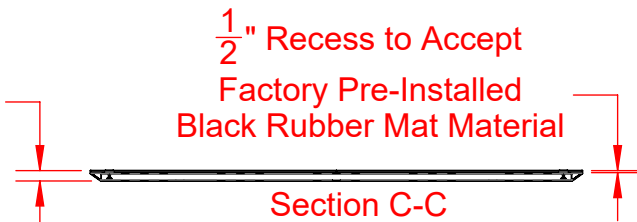

Section C-C

PROPRIETARY AND CONFIDENTIAL

THE INFORMATION CONTAINED IN THIS DRAWING IS THE SOLE PROPERTY OF SPORTSFIELD SPECIALTIES INC. ANY REPRODUCTION IN PART OR AS A WHOLE WITHOUT THE WRITTEN PERMISSION OF SPORTSFIELD SPECIALTIES INC. IS PROHIBITED.

SPCVRHSM - High School Sand Pit Cover Set with Factory Pre-Installed Black Rubber Mat Material

Not To Scale

Sportsfield Specialties Inc 105838.1-221222

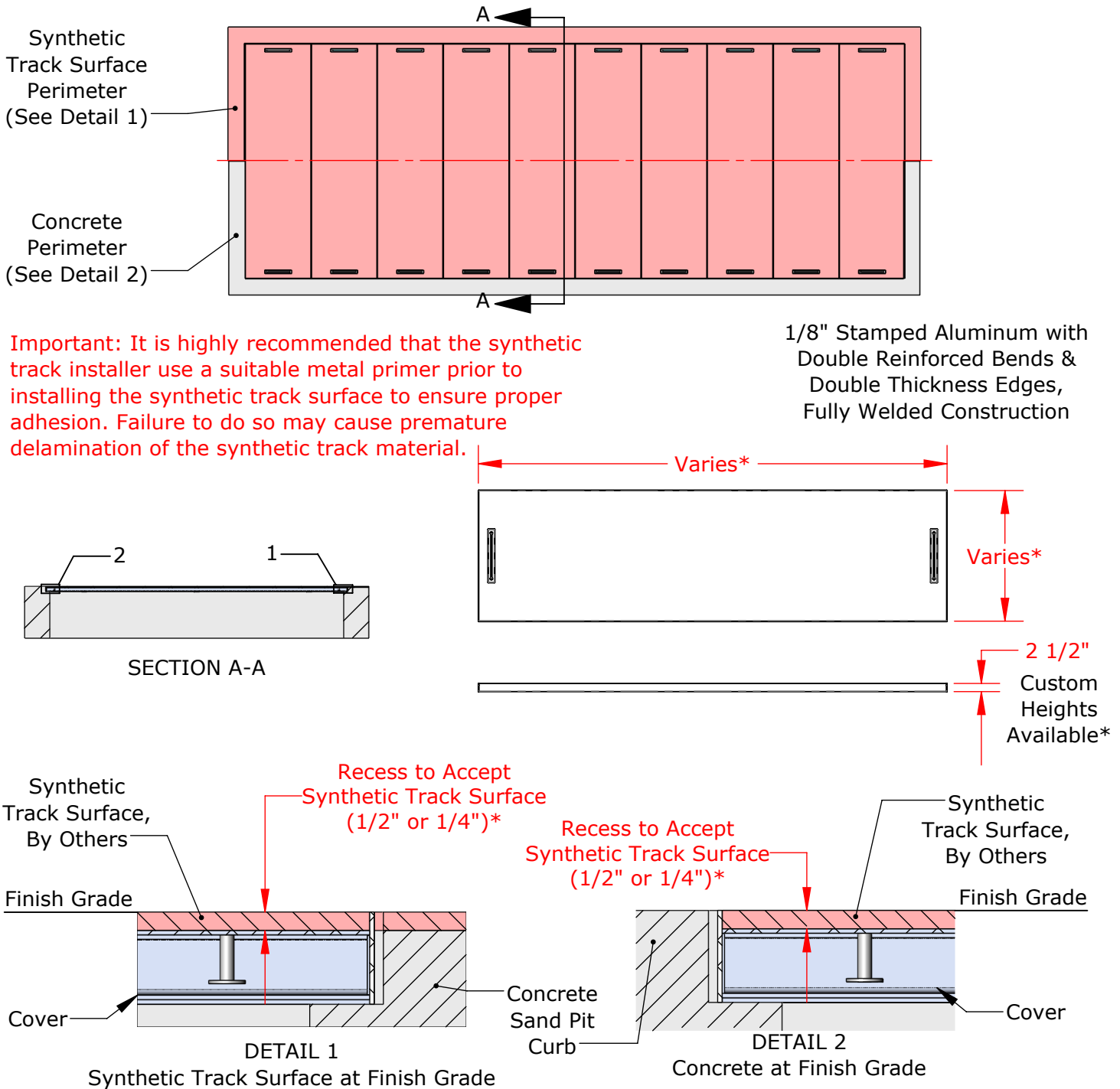

Important: It is highly recommended that the synthetic track installer use a suitable metal primer prior to installing the synthetic track surface to ensure proper adhesion. Failure to do so may cause premature delamination of the synthetic track material.

1/8" Stamped Aluminum with Double Reinforced Bends & Double Thickness Edges, Fully Welded Construction

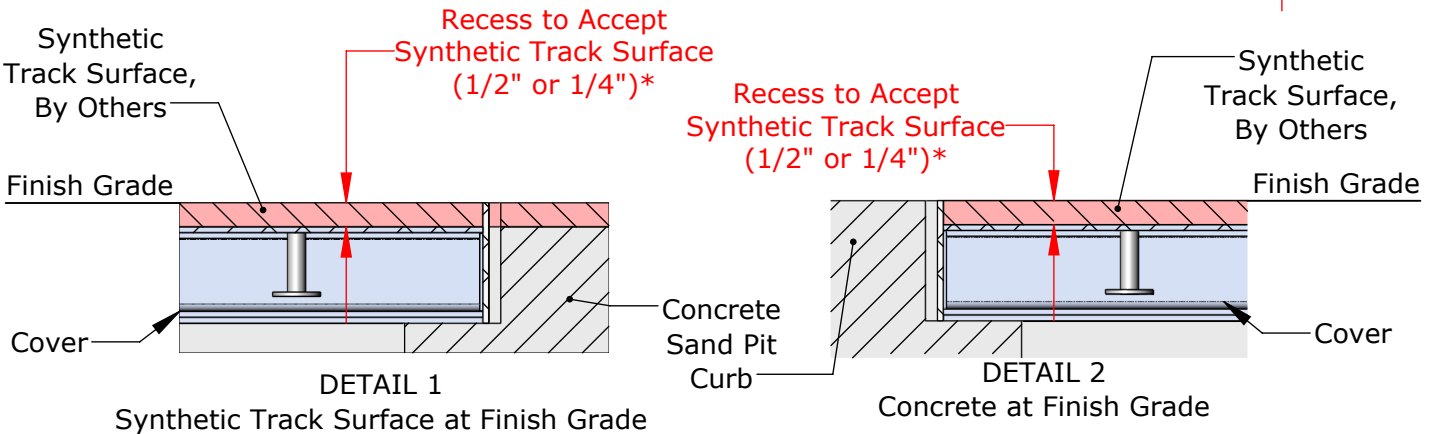

NOTE: Manufacturer's recommended cover ledge dimensions are 2-1/2"H X 2-1/2"W

*Customer Needs to Complete Custom Sand Pit Cover Set Order Form

PROPRIETARY AND CONFIDENTIAL

THE INFORMATION CONTAINED IN THIS DRAWING IS THE SOLE PROPERTY OF SPORTSFIELD SPECIALTIES INC. ANY REPRODUCTION IN PART OR AS A WHOLE WITHOUT THE WRITTEN PERMISSION OF SPORTSFIELD SPECIALTIES INC. IS PROHIBITED.

SPCVRCSTM Custom Sand Pit Cover Set

Not To Scale

Sportsfield Specialties Inc 07282020

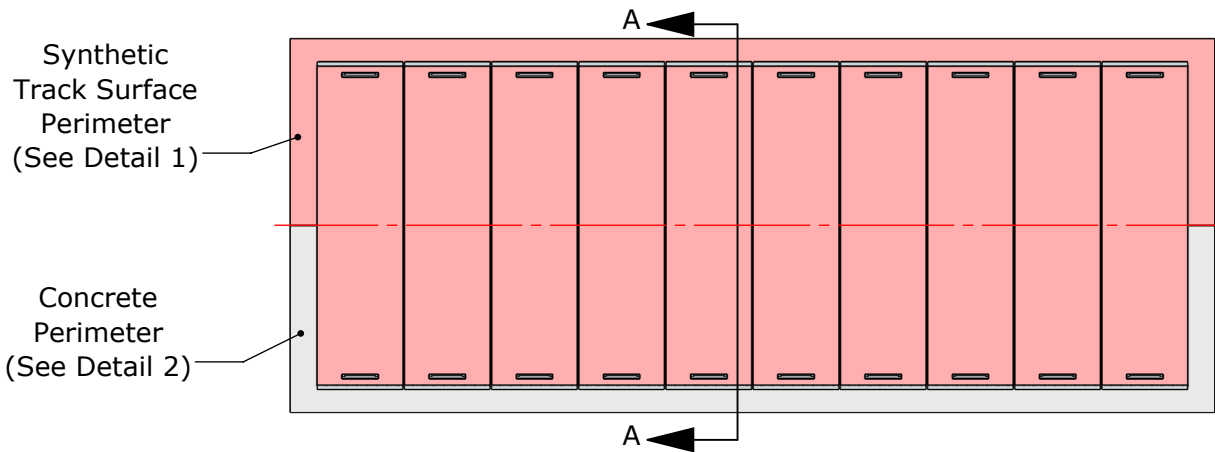

Important: It is highly recommended that the synthetic track installer use a suitable metal primer prior to installing the synthetic track surface to ensure proper adhesion. Failure to do so may cause premature delamination of the synthetic track material.

1/8" Stamped Aluminum with
Double Reinforced Bends &
3/16" Aluminum Hanging Angle,
Fully Welded Construction

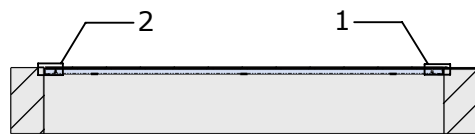

SECTION A-A

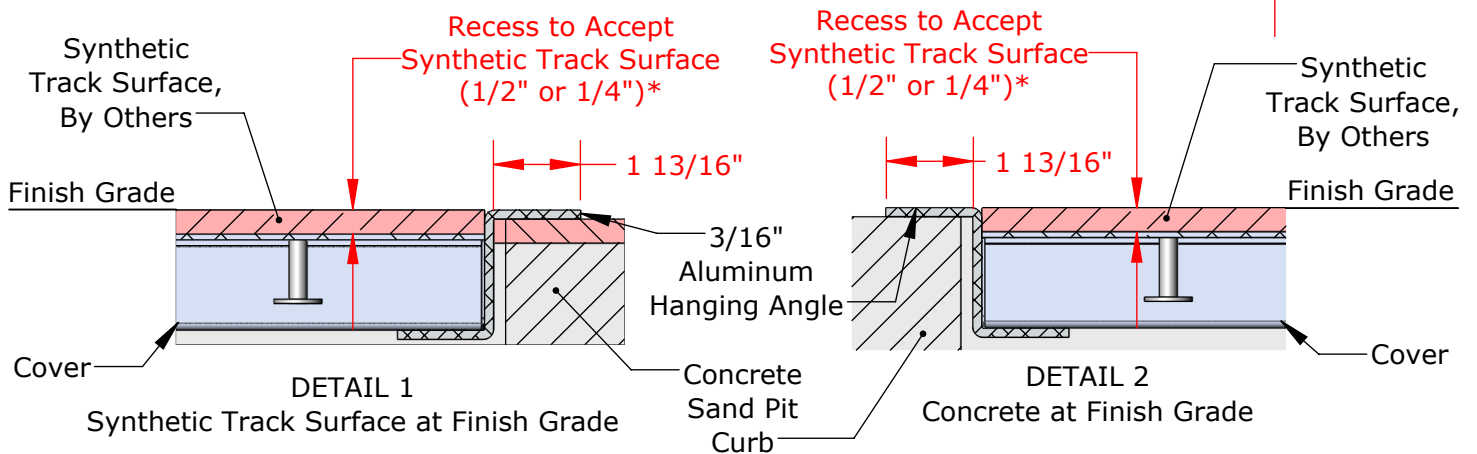
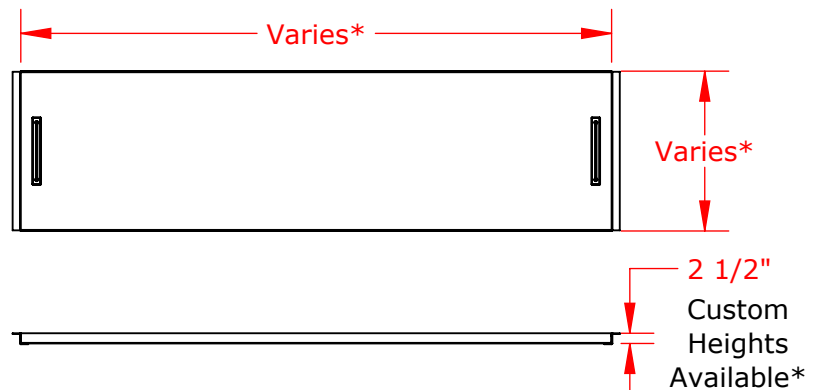

***Customer Needs to Complete Custom Hanging Sand Pit Cover Set Order Form**

PROPRIETARY AND CONFIDENTIAL

THE INFORMATION CONTAINED IN THIS DRAWING IS THE SOLE PROPERTY OF SPORTSFIELD SPECIALTIES INC. ANY REPRODUCTION IN PART OR AS A WHOLE WITHOUT THE WRITTEN PERMISSION OF SPORTSFIELD SPECIALTIES INC. IS PROHIBITED.

SPCVRCSTMH Custom Hanging Sand Pit Cover Set

Not To Scale

Sportsfield Specialties Inc 07222020

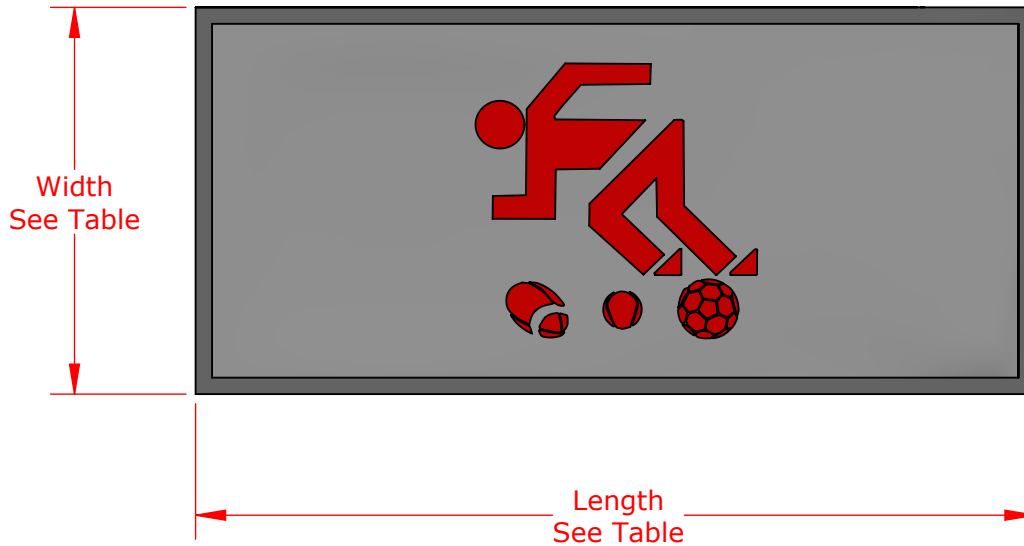

Custom Sizing Available

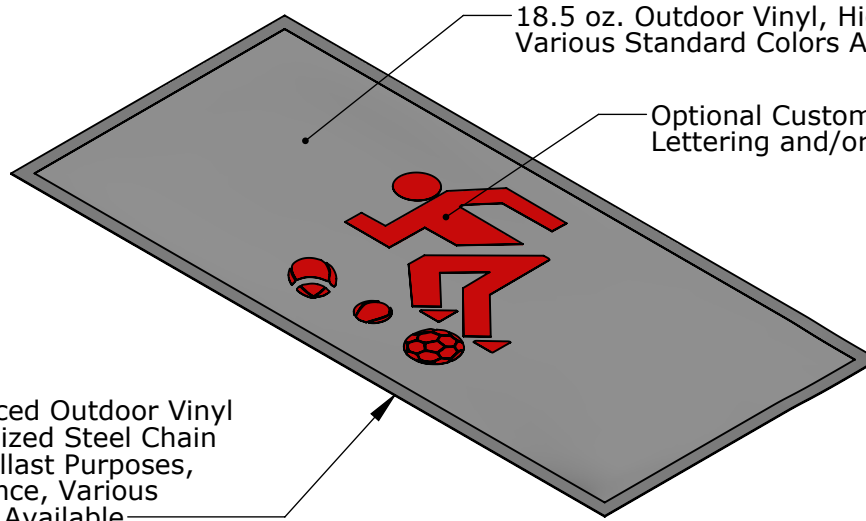

18.5 oz. Outdoor Vinyl, High UV Resistance, Various Standard Colors Available

Optional Custom Digitally Printed Lettering and/or Graphics

18.5 oz. Reinforced Outdoor Vinyl Wrapped Galvanized Steel Chain Perimeter for Ballast Purposes, High UV Resistance, Various Standard Colors Available

Part Numbers *	Width	Length
SPCVRV/SPCVRVDG	11'-9"	25'-6"
SPCVRVL/SPCVRVLDG	11'-9"	31'-6"
SPCVRVCSTM/SPCVRVCSTMDG	CUSTOM	CUSTOM

*DG Part Number Denotes Custom Digitally Printed Graphics

PROPRIETARY AND CONFIDENTIAL

THE INFORMATION CONTAINED IN THIS DRAWING IS THE SOLE PROPERTY OF SPORTSFIELD SPECIALTIES INC. ANY REPRODUCTION IN PART OR AS A WHOLE WITHOUT THE WRITTEN PERMISSION OF SPORTSFIELD SPECIALTIES INC. IS PROHIBITED.

Weighted Vinyl Long/Triple Jump Sand Pit Covers

Not To Scale

Sportsfield Specialties Inc 07012021

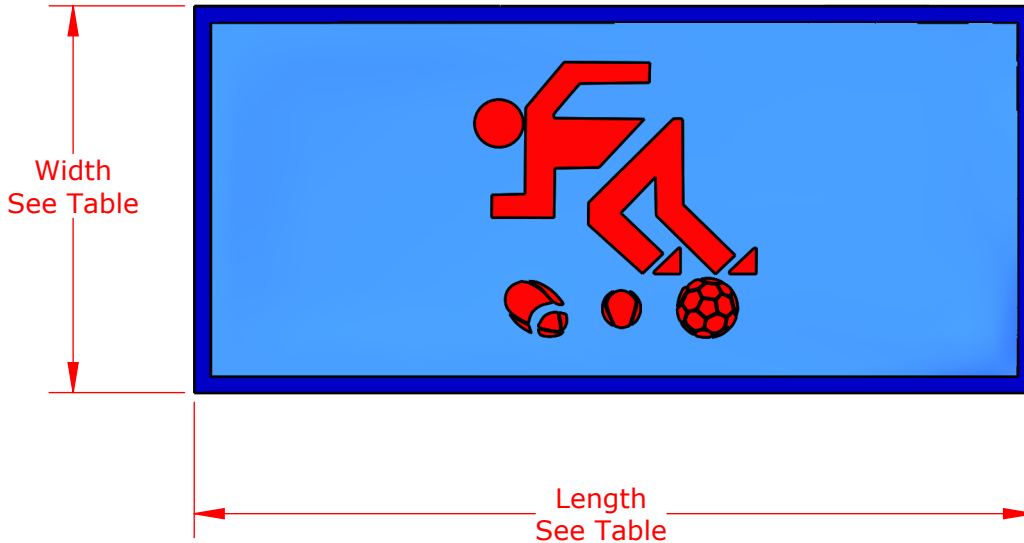

Custom Sizing Available

Vinyl Coated Mesh, Single or Double Layer Construction, Various Standard Colors Available

Optional Custom Digitally Printed Lettering and/or Graphics

18.5 oz. Reinforced Outdoor Vinyl Wrapped Galvanized Steel Chain Perimeter for Ballast Purposes, High UV Resistance, Various Standard Colors Available

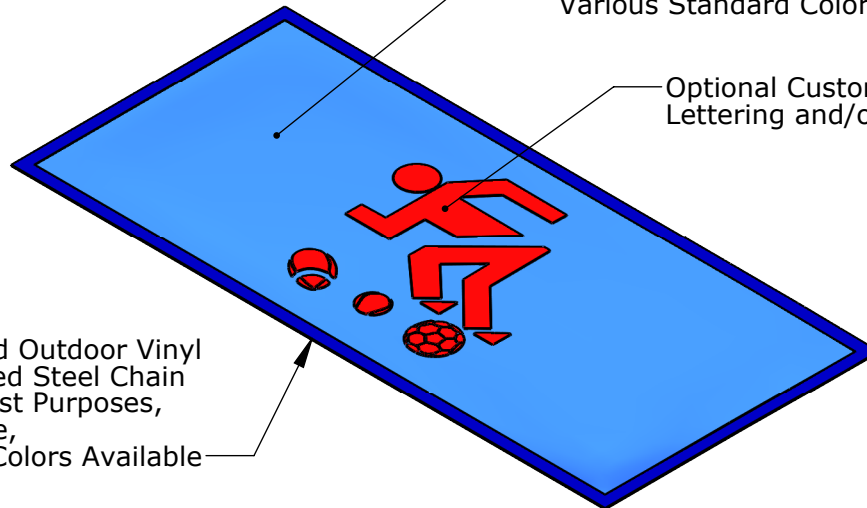

Part Numbers *	Width	Length	Mesh Type
SPCVRM/SPCVRMDG	11'-9"	25'-6"	SINGLE LAYER MESH
SPCVRML/SPCVRMLDG	11'-9"	31'-6"	SINGLE LAYER MESH
SPCVRMCSTM/SPCVRMCSTMDG	CUSTOM	CUSTOM	SINGLE LAYER MESH
SPCVRMD/SPCVRMDDG	11'-9"	25'-6"	DOUBLE LAYER MESH
SPCVRMDL/SPCVRMDLDG	11'-9"	31'-6"	DOUBLE LAYER MESH
SPCVRMDCSTM/SPCVRMDCSTMDG	CUSTOM	CUSTOM	DOUBLE LAYER MESH

*DG Part Number Denotes Custom Digitally Printed Graphics

PROPRIETARY AND CONFIDENTIAL

THE INFORMATION CONTAINED IN THIS DRAWING IS THE SOLE PROPERTY OF SPORTSFIELD SPECIALTIES INC. ANY REPRODUCTION IN PART OR AS A WHOLE WITHOUT THE WRITTEN PERMISSION OF SPORTSFIELD SPECIALTIES INC. IS PROHIBITED.

Weighted Mesh Long/Triple Jump Sand Pit Covers

Not To Scale

Sportsfield Specialties Inc 07012021

United States Patent # 8,337,318, Issued December 25, 2012

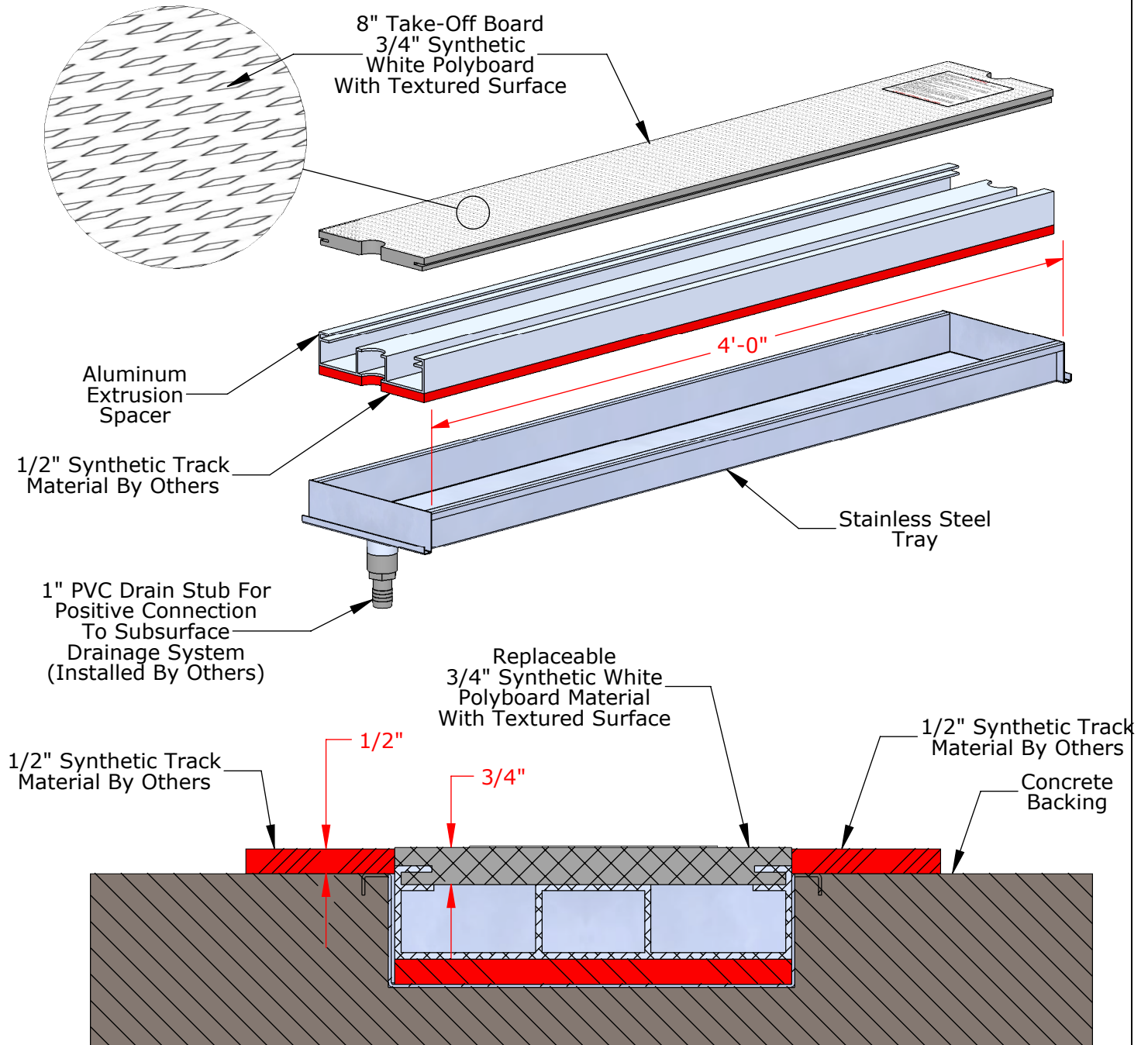

Important:

This Board should ONLY be used with proper track spikes at all levels of practice and/or competition. If track spikes are NOT used, the track surface side of the insert or blanking lid should be facing up.

PROPRIETARY AND CONFIDENTIAL

THE INFORMATION CONTAINED IN THIS DRAWING IS THE SOLE PROPERTY OF SPORTSFIELD SPECIALTIES INC. ANY REPRODUCTION IN PART OR AS A WHOLE WITHOUT THE WRITTEN PERMISSION OF SPORTSFIELD SPECIALTIES INC. IS PROHIBITED.

LTJT0B8 (TFLT008SS-SYN)
8" Long/Triple Jump Polyboard Take-Off Board System

Not To Scale

Sportsfield Specialties Inc 03042020

United States Patent # 8,337,318, Issued December 25, 2012

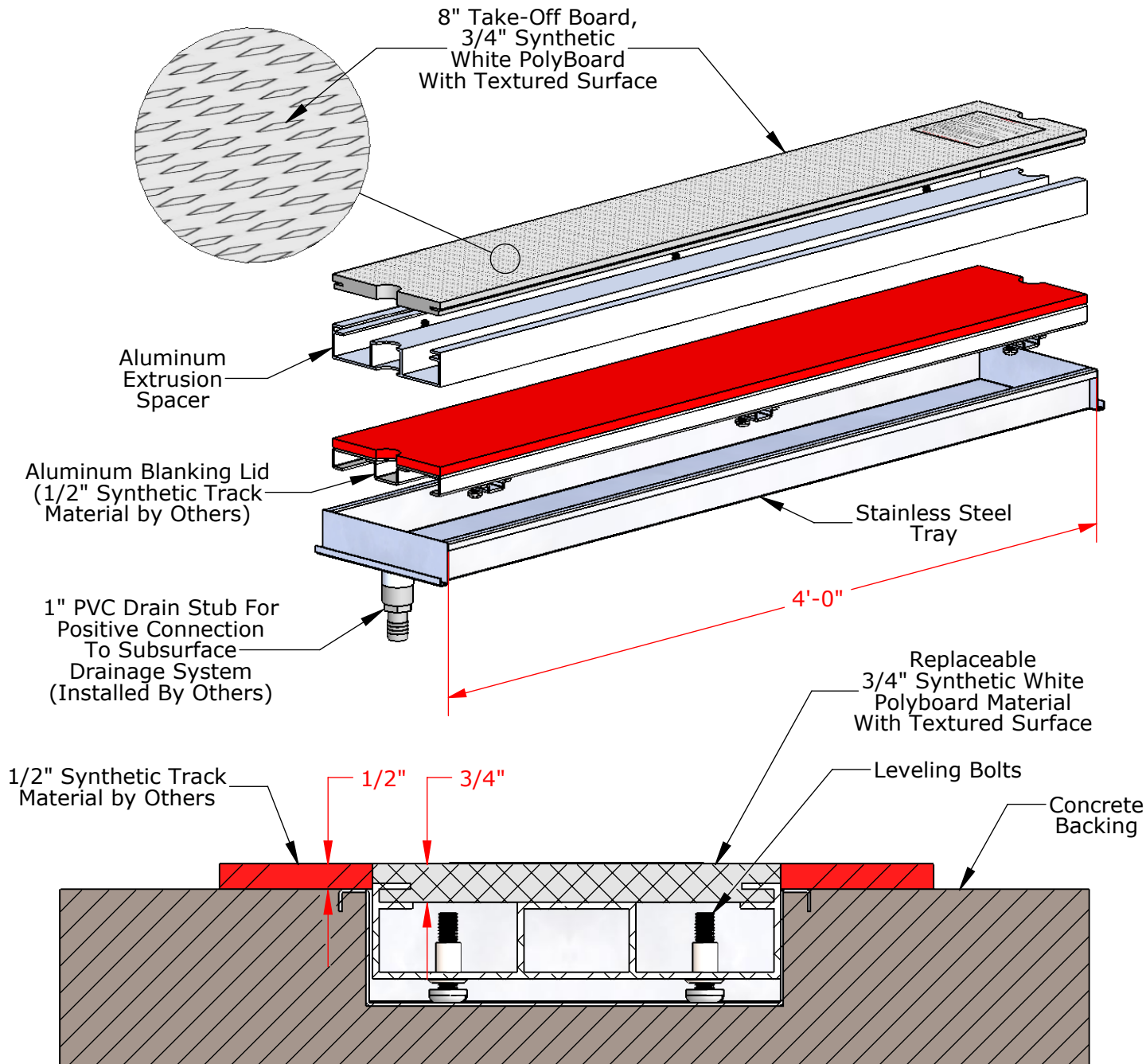

Important:

This Board should ONLY be used with proper track spikes at all levels of practice and/or competition. If track spikes are NOT used, the track surface side of the insert or blanking lid should be facing up.

PROPRIETARY AND CONFIDENTIAL

THE INFORMATION CONTAINED IN THIS DRAWING IS THE SOLE PROPERTY OF SPORTSFIELD SPECIALTIES INC. ANY REPRODUCTION IN PART OR AS A WHOLE WITHOUT THE WRITTEN PERMISSION OF SPORTSFIELD SPECIALTIES INC. IS PROHIBITED.

LTJTOB8BL (TFLTP008SS-SYN-BL) 8" Long/Triple Jump Polyboard Take-Off Board System with Replacement Blanking Lid

Not To Scale

Sportsfield Specialties Inc 03042020

United States Patent # 8,337,318, Issued December 25, 2012

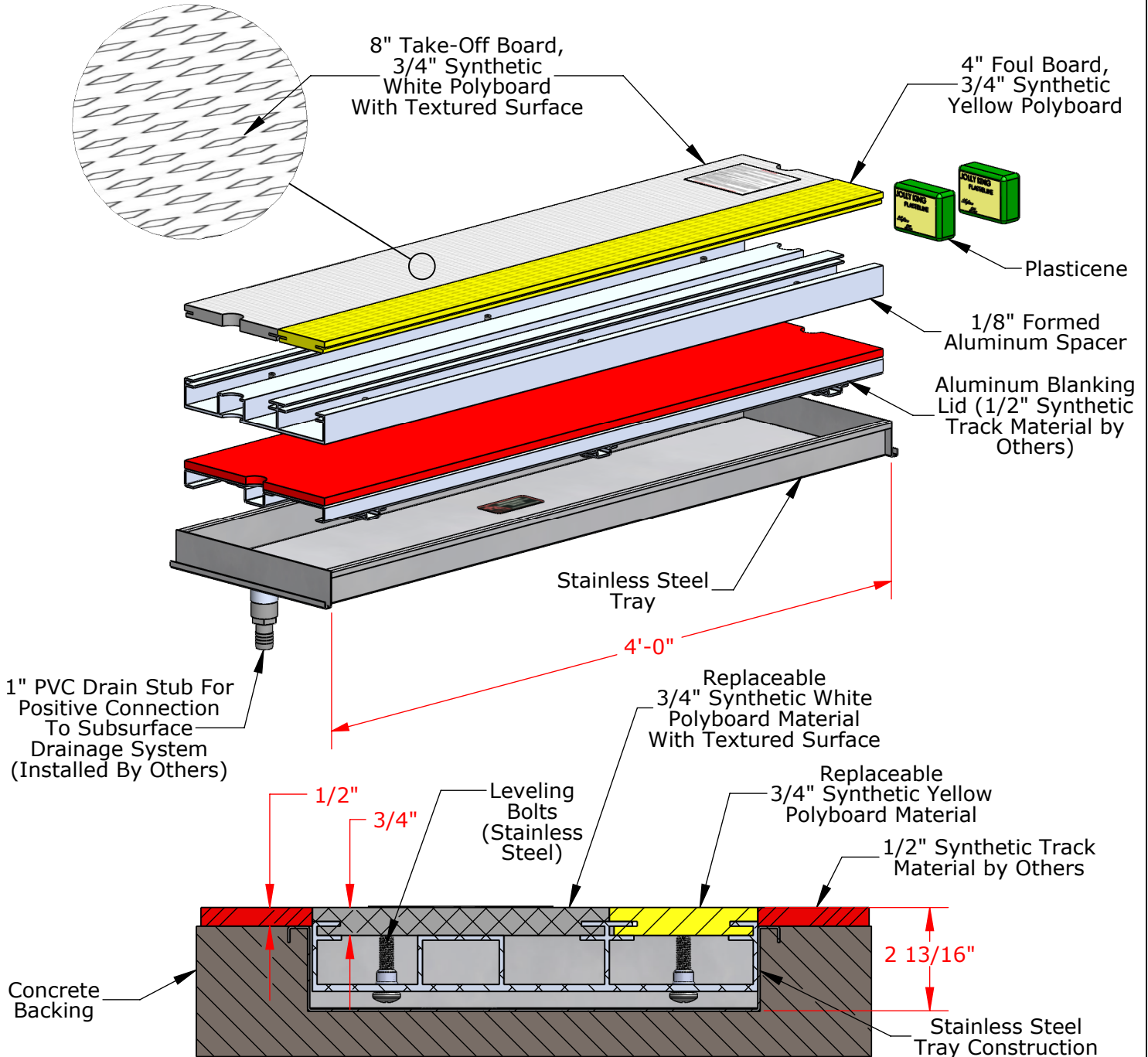

Important:

This Board should ONLY be used with proper track spikes at all levels of practice and/or competition. If track spikes are NOT used, the track surface side of the insert or blanking lid should be facing up.

PROPRIETARY AND CONFIDENTIAL

THE INFORMATION CONTAINED IN THIS DRAWING IS THE SOLE PROPERTY OF SPORTSFIELD SPECIALTIES INC. ANY REPRODUCTION IN PART OR AS A WHOLE WITHOUT THE WRITTEN PERMISSION OF SPORTSFIELD SPECIALTIES INC. IS PROHIBITED.

LTJTOB12 12" Long/Triple Jump Polyboard Take-Off Board System with Replacement Blanking Lid

Not To Scale

Sportsfield Specialties Inc 106112.1-230111

United States Patent # 8,337,318, Issued December 25, 2012

World Athletics (IAAF) Certified

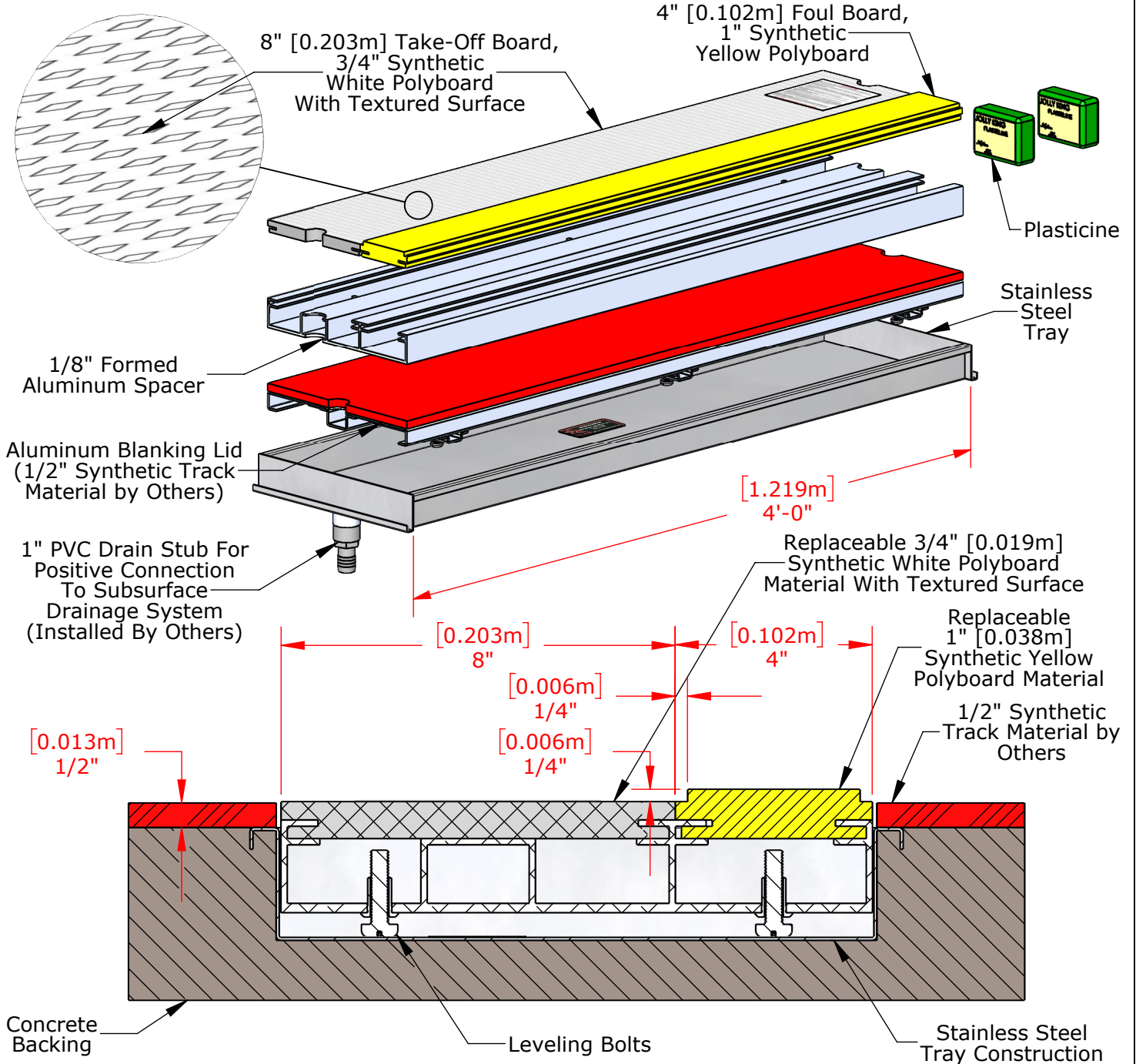

Important:

This Board should ONLY be used with proper track spikes at all levels of practice and/or competition. If track spikes are NOT used, the track surface side of the insert or blanking lid should be facing up.

PROPRIETARY AND CONFIDENTIAL

THE INFORMATION CONTAINED IN THIS DRAWING IS THE SOLE PROPERTY OF SPORTSFIELD SPECIALTIES INC. ANY REPRODUCTION IN PART OR AS A WHOLE WITHOUT THE WRITTEN PERMISSION OF SPORTSFIELD SPECIALTIES INC. IS PROHIBITED.

LTJT0B12IAAF 12" Long/Triple Jump Polyboard World Athletics (IAAF) Take-Off Board System with Replacement Blanking Lid

Not To Scale

Sportsfield Specialties Inc 03212022

United States Patent # 8,337,318, Issued December 25, 2012

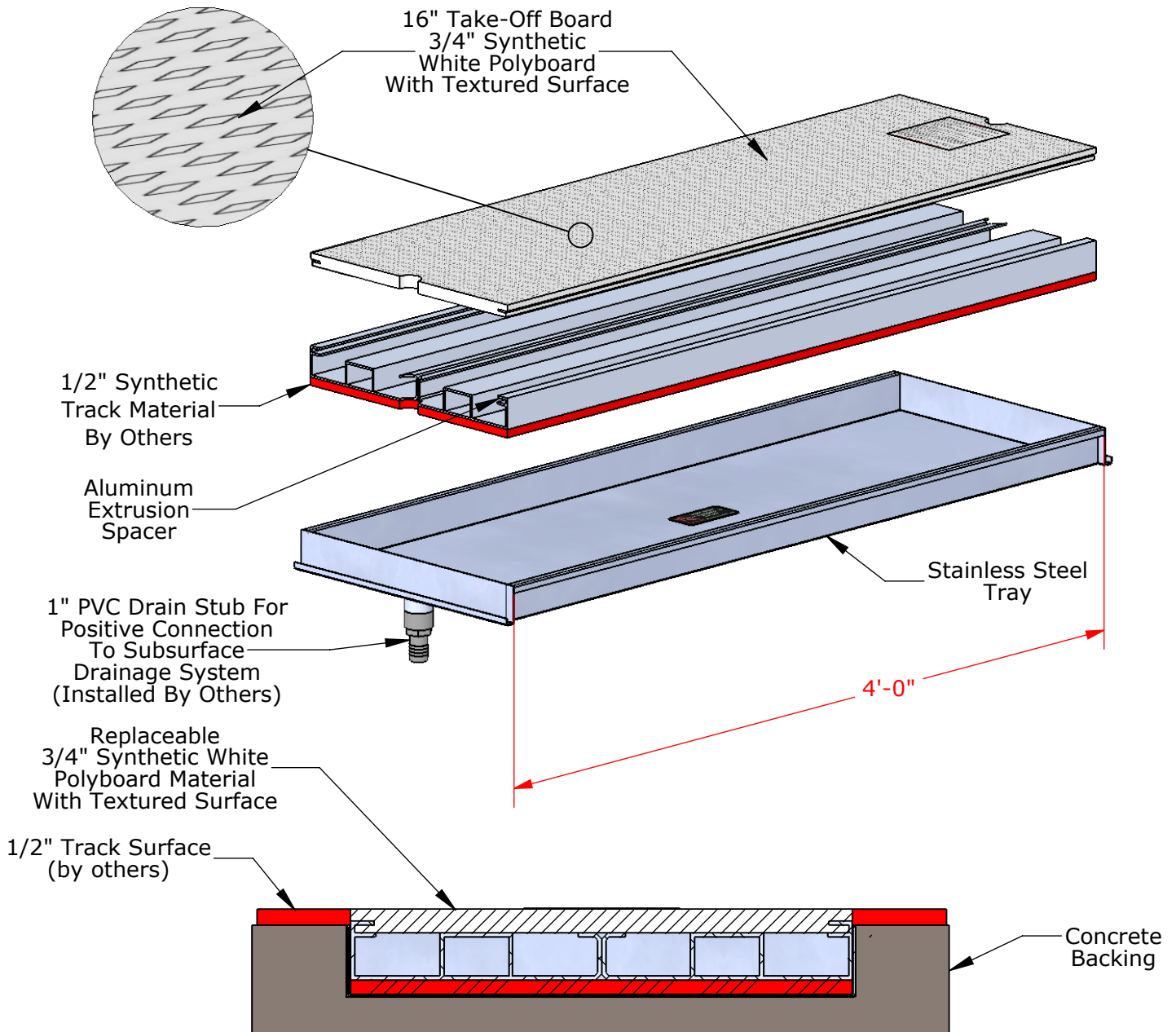

Important:

This Board should ONLY be used with proper track spikes at all levels of practice and/or competition. If track spikes are NOT used, the track surface side of the insert or blanking lid should be facing up.

PROPRIETARY AND CONFIDENTIAL

THE INFORMATION CONTAINED IN THIS DRAWING IS THE SOLE PROPERTY OF SPORTSFIELD SPECIALTIES INC. ANY REPRODUCTION IN PART OR AS A WHOLE WITHOUT THE WRITTEN PERMISSION OF SPORTSFIELD SPECIALTIES INC. IS PROHIBITED.

LTJTOB16 (TFLT016SS-SYN) 16" Long/Triple Jump Polyboard Take-Off Board System

Not To Scale

Sportsfield Specialties Inc 03042020

United States Patent # 8,337,318, Issued December 25, 2012

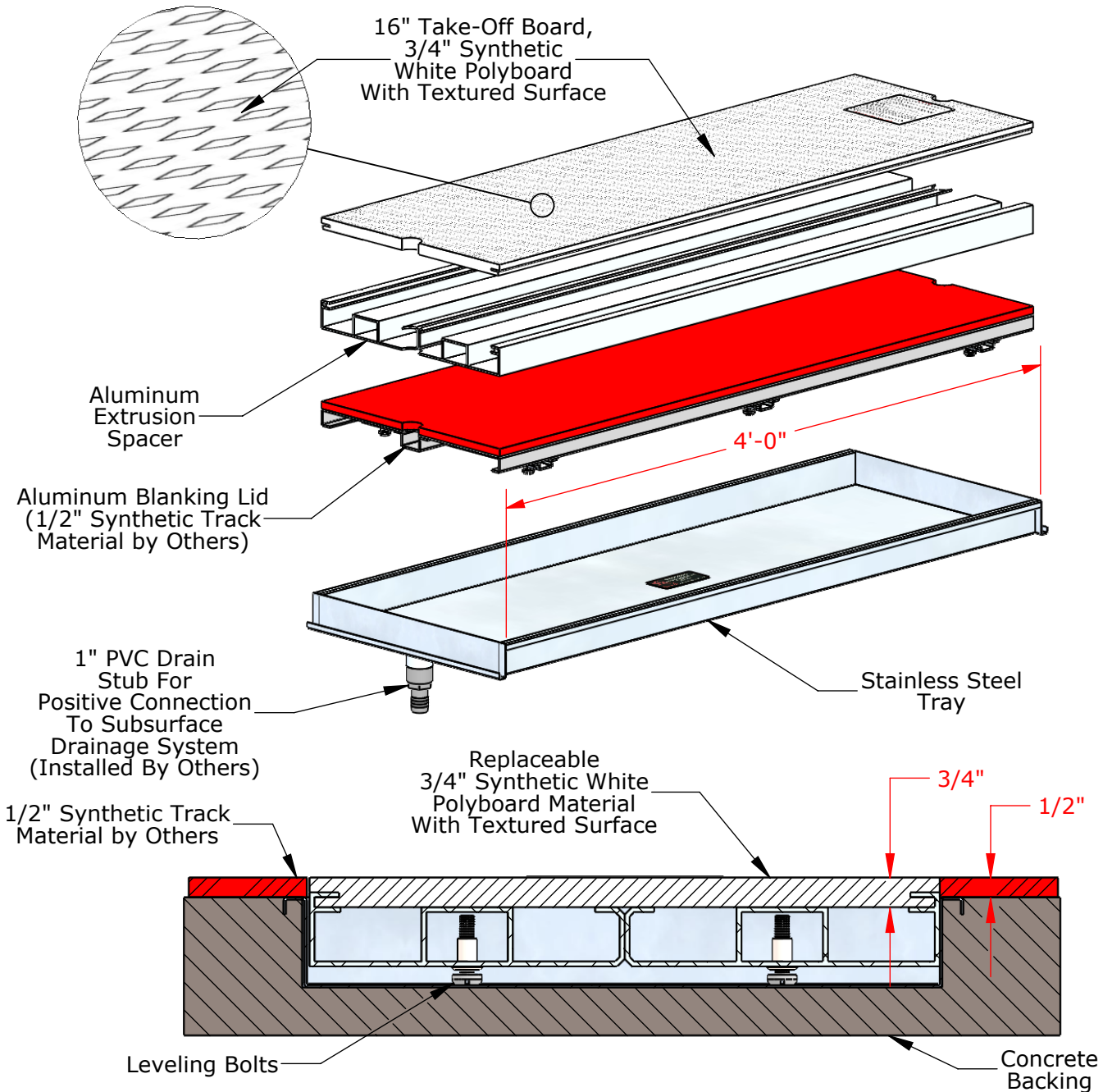

Important:

This Board should ONLY be used with proper track spikes at all levels of practice and/or competition. If track spikes are NOT used, the track surface side of the insert or blanking lid should be facing up.

PROPRIETARY AND CONFIDENTIAL

THE INFORMATION CONTAINED IN THIS DRAWING IS THE SOLE PROPERTY OF SPORTSFIELD SPECIALTIES INC. ANY REPRODUCTION IN PART OR AS A WHOLE WITHOUT THE WRITTEN PERMISSION OF SPORTSFIELD SPECIALTIES INC. IS PROHIBITED.

LTJTOB16BL (TFLT016SS-SYN-BL) 16" Long/Triple Jump Polyboard Take-Off Board System with Replacement Blanking Lid

Not To Scale

Sportsfield Specialties Inc 03042020

United States Patent # 8,337,318, Issued December 25, 2012

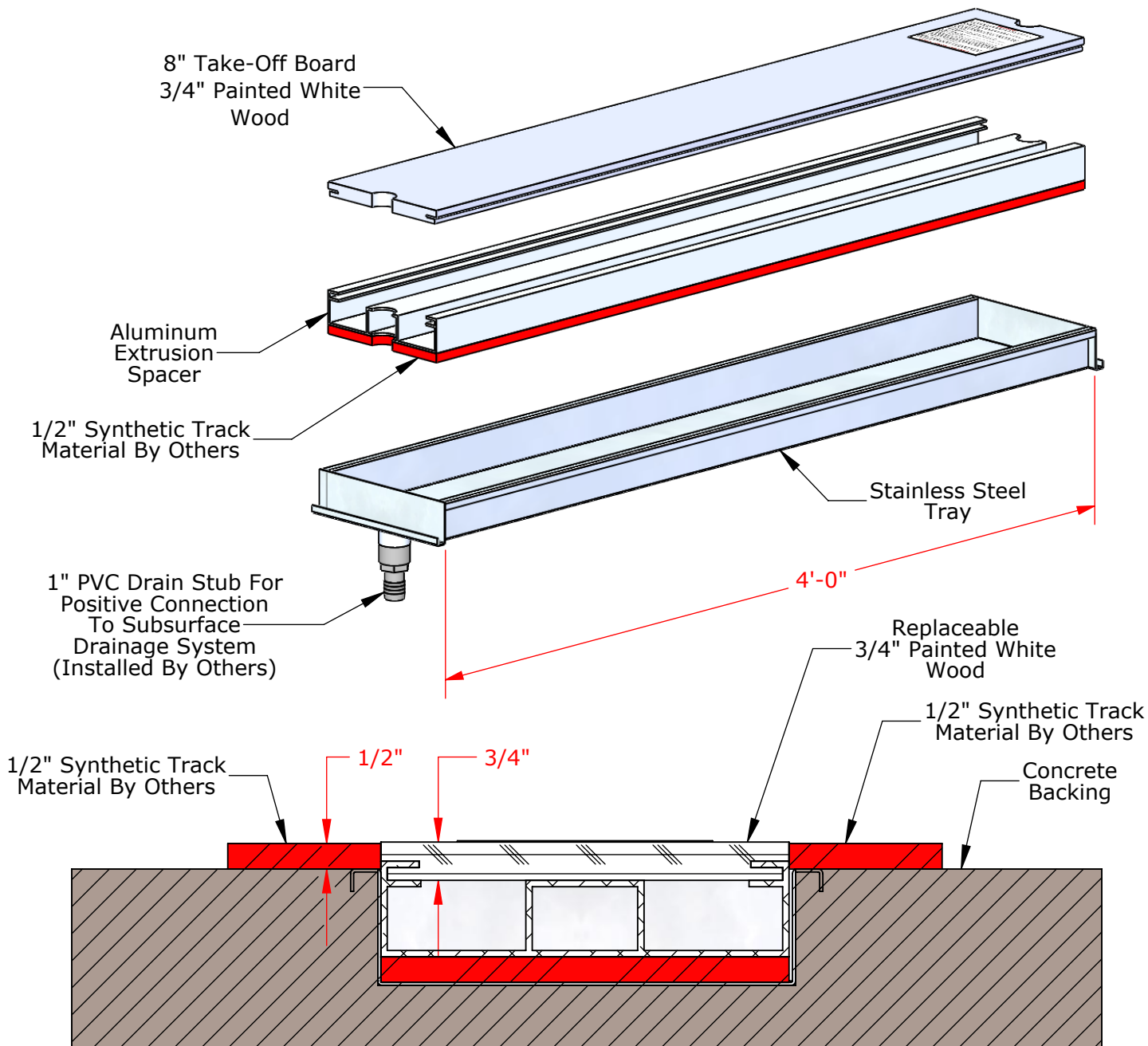

Important:

This Board should ONLY be used with proper track spikes at all levels of practice and/or competition. If track spikes are NOT used, the track surface side of the insert or blanking lid should be facing up.

PROPRIETARY AND CONFIDENTIAL

THE INFORMATION CONTAINED IN THIS DRAWING IS THE SOLE PROPERTY OF SPORTSFIELD SPECIALTIES INC. ANY REPRODUCTION IN PART OR AS A WHOLE WITHOUT THE WRITTEN PERMISSION OF SPORTSFIELD SPECIALTIES INC. IS PROHIBITED.

LTJT0B8W (TFLTP008SS) 8" Long/Triple Jump Wood Take-Off Board System

Not To Scale

Sportsfield Specialties Inc 03042020

United States Patent # 8,337,318, Issued December 25, 2012

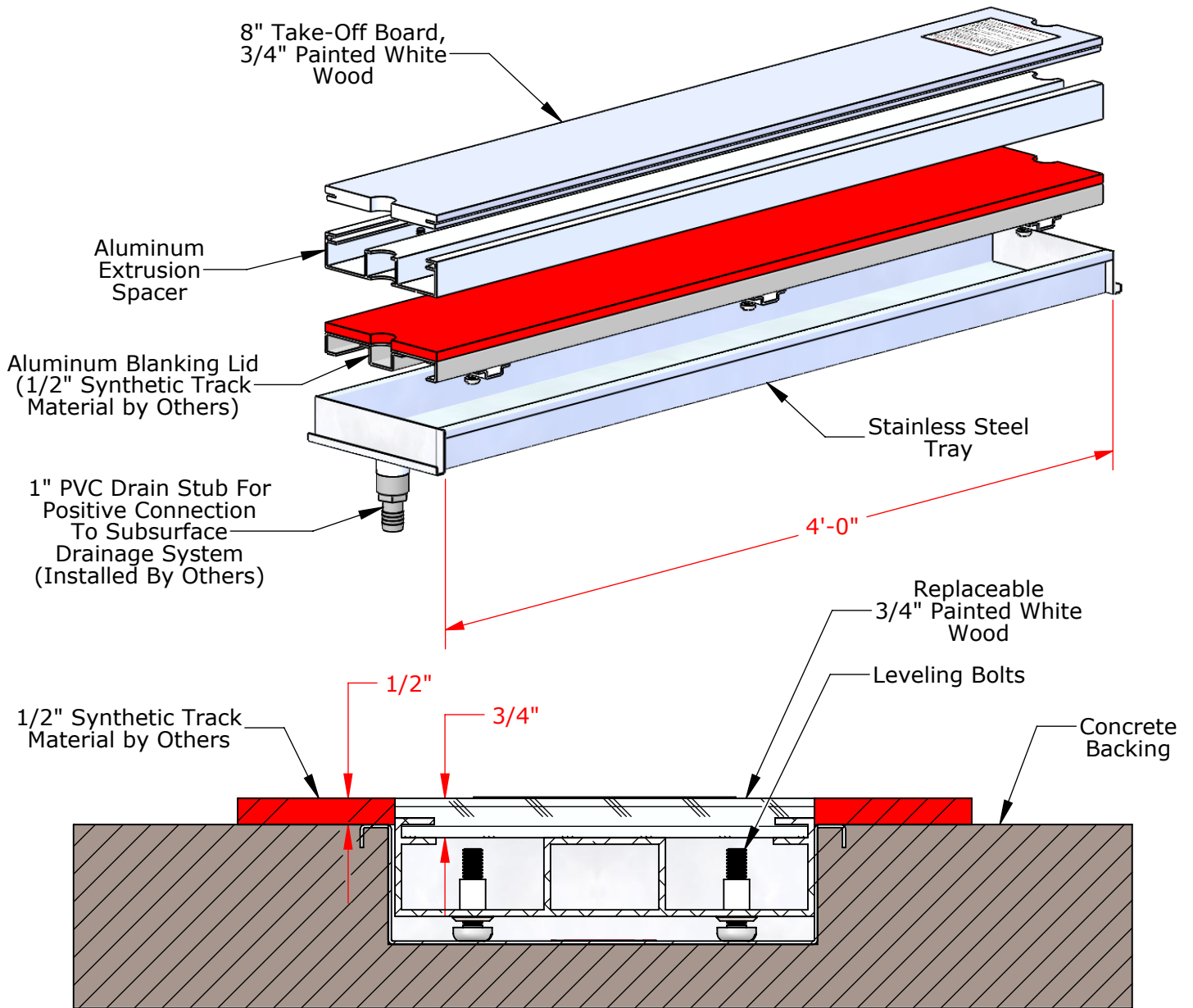

Important:

This Board should ONLY be used with proper track spikes at all levels of practice and/or competition. If track spikes are NOT used, the track surface side of the insert or blanking lid should be facing up.

PROPRIETARY AND CONFIDENTIAL

THE INFORMATION CONTAINED IN THIS DRAWING IS THE SOLE PROPERTY OF SPORTSFIELD SPECIALTIES INC. ANY REPRODUCTION IN PART OR AS A WHOLE WITHOUT THE WRITTEN PERMISSION OF SPORTSFIELD SPECIALTIES INC. IS PROHIBITED.

LTJTOB8BLW (TFLTP008SS-BL) 8" Long/Triple Jump Wood Take-Off Board System with Replacement Blanking Lid

Not To Scale

Sportsfield Specialties Inc 03042020

United States Patent # 8,337,318, Issued December 25, 2012

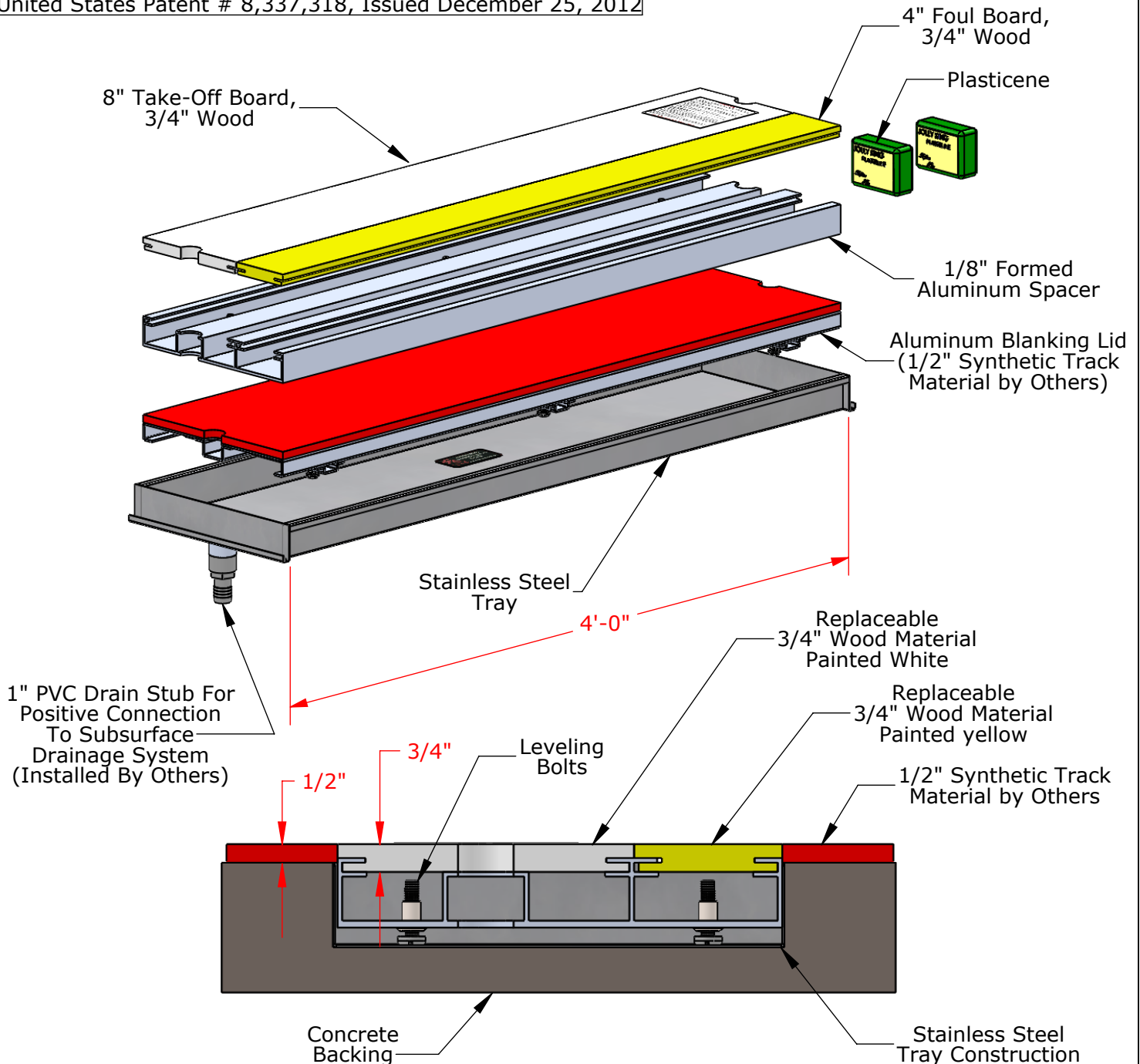

Important:

This Board should ONLY be used with proper track spikes at all levels of practice and/or competition. If track spikes are NOT used, the track surface side of the insert or blanking lid should be facing up.

PROPRIETARY AND CONFIDENTIAL

THE INFORMATION CONTAINED IN THIS DRAWING IS THE SOLE PROPERTY OF SPORTSFIELD SPECIALTIES INC. ANY REPRODUCTION IN PART OR AS A WHOLE WITHOUT THE WRITTEN PERMISSION OF SPORTSFIELD SPECIALTIES INC. IS PROHIBITED.

LJTTOB12W (TFLTP012SS) 12" Long/Triple Jump Wood Take-Off Board System with Replacement Blanking Lid

Not To Scale

Sportsfield Specialties Inc 03042020

United States Patent # 8,337,318, Issued December 25, 2012

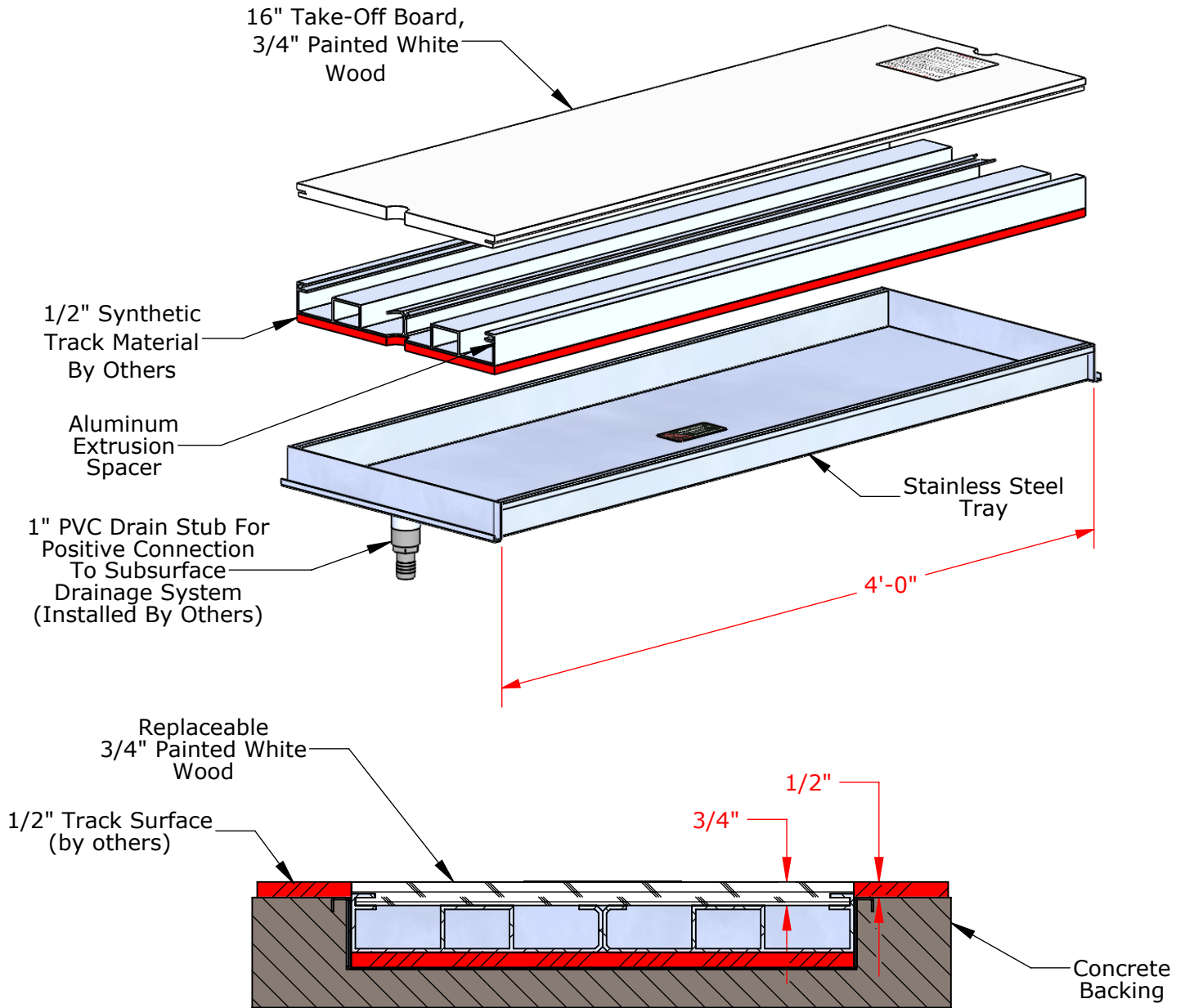

Important:

This Board should ONLY be used with proper track spikes at all levels of practice and/or competition. If track spikes are NOT used, the track surface side of the insert or blanking lid should be facing up.

PROPRIETARY AND CONFIDENTIAL

THE INFORMATION CONTAINED IN THIS DRAWING IS THE SOLE PROPERTY OF SPORTSFIELD SPECIALTIES INC. ANY REPRODUCTION IN PART OR AS A WHOLE WITHOUT THE WRITTEN PERMISSION OF SPORTSFIELD SPECIALTIES INC. IS PROHIBITED.

LTJTOB16W (TFLTP016SS) 8" Long/Triple Jump Wood Take-Off Board System

Not To Scale

Sportsfield Specialties Inc 03042020

United States Patent # 8,337,318, Issued December 25, 2012

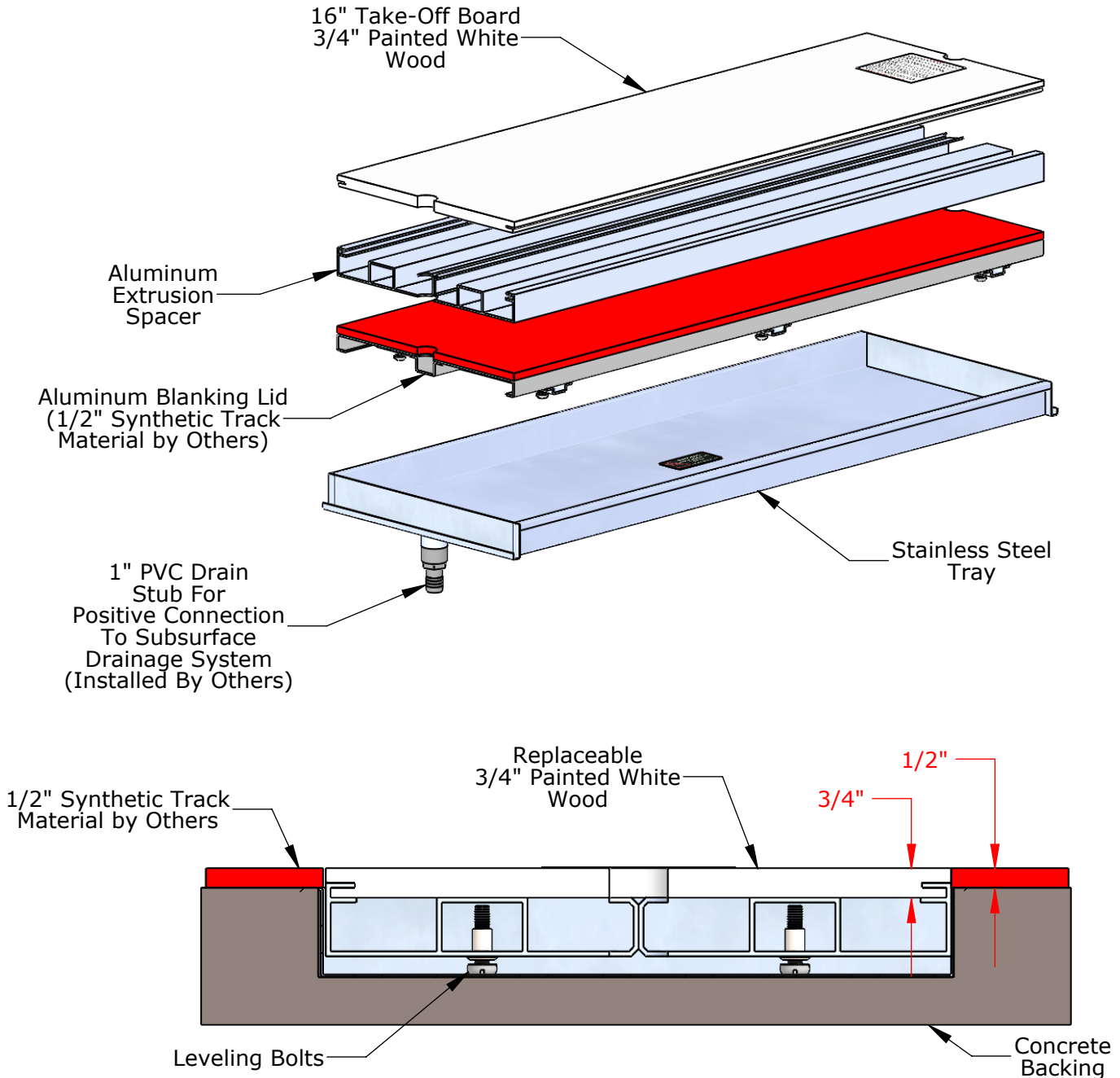

Important:

This Board should ONLY be used with proper track spikes at all levels of practice and/or competition. If track spikes are NOT used, the track surface side of the insert or blanking lid should be facing up.

PROPRIETARY AND CONFIDENTIAL

THE INFORMATION CONTAINED IN THIS DRAWING IS THE SOLE PROPERTY OF SPORTSFIELD SPECIALTIES INC. ANY REPRODUCTION IN PART OR AS A WHOLE WITHOUT THE WRITTEN PERMISSION OF SPORTSFIELD SPECIALTIES INC. IS PROHIBITED.

**LTJTOB16BLW (TFLT016SS-BL) 16" Long/Triple Jump Wood
Take-Off Board System with Replacement Blanking Lid**

Not To Scale

Sportsfield Specialties Inc 03042020